

Appendix I

**NOTE: Appendix Information is for Reference Only.
Contact Local Entity Engineer for Current
Information.**

Appendix I shall be used as a reference for Roundabout Design within the City Limits of Fort Collins and Loveland, and within Larimer County GMAs.



Roundabout Design Manual

LCUASS Appendix I

City of Loveland
City of Fort Collins
Larimer County

August 1, 2021



Contents

A. Introduction.....	3
B. General Design Criteria	4
1. Appropriate Roadways/Locations	4
2. Approach & Circulatory Speeds.....	4
3. Design Vehicle	5
4. Pedestrian / Bicycles.....	5
5. Design Software	6
6. Utilities & Drainage.....	7
7. Landscaping.....	7
8. Other.....	7
C. Specific / Geometric Design Elements.....	8
1. Critical Geometry	8
2. Roundabout Design Approach.....	8
3. Circulating Roadway	9
4. Sight Distance.....	9
5. Splitter Islands.....	9
6. Central Island.....	10
7. Signing & Marking.....	10
8. Landscaping Design Elements.....	11
D. Definitions	13
Exhibits.....	14
Figure 1 – Roundabout Terminology.....	14
Figure 2 – Fast Path (4 Lane/4 Lane).....	15
Figure 3 – Fast Path (2 Lane/2 Lane).....	16
Figure 4 –Sight Distance.....	17
Figure 5 – Construction Details	18
Figure 6 – Construction Details (continued).....	19
Figure 7 – Bicycle Path and Ramp Detail.....	20
Figure 8 – Standard Signing	21
Figure 9A – Standard Signing (continued)	22
Figure 9B – Standard Signing (continued)	23
Figure 10 – 4 Lane by 4 Lane Arterial.....	24
Figure 11 – 2 Lane by 4 Lane Arterial.....	25
Figure 12 – 2 Lane by 4 Lane Arterial with Bypass Lane	26
Figure 13 – 2 Lane by 2 Lane Arterial.....	27
Figure 14 –Collector	28
Figure 15 –Mini	29
Figure 16 – Residential Compact.....	30

A. Introduction

These guidelines are to be used, along with information from other sources and engineering judgment, in the design of all roundabouts. Where conflicting information exists, this manual shall govern, or the local entity can provide clarification.

When designing roundabouts, there are several characteristics that can be standardized, such as signing and marking; while others must be adapted to fit the demands of the location, such as approach angles and right of way restrictions. This manual has been created to allow engineers sufficient flexibility to design a roundabout to fit a particular site, while still maintaining consistency with other roundabouts within the Local Entity in order to enhance driver expectancy.

All roundabout designs will be required to follow a four-stage process (scoping meeting, conceptual design, preliminary design, and final design), and these stages shall run concurrently with the overall development review process:

- The Roundabout Scoping meeting will deal specifically with any proposed roundabout intersections, and will be scheduled within two weeks of the Local Entity's receipt of a completed *Roundabout Scoping Form* and any ancillary information necessary to determine the parameters of the proposed roundabout. The intent of the scoping meeting is to clearly define the expectations for design of the proposed roundabout and to discuss particular site-specific challenges.
- The conceptual design is intended to vet the general capacity issues, and performance of a roundabout, conceptual location/layout, and pedestrian / bicycle safety issues based upon direction given in the scoping meeting.
- Submission of a preliminary design that meets design criteria listed herein, or as modified in accordance with guidance provided by the Local Entity during the scoping or conceptual design stages of review. Horizontal design of the proposed roundabout shall be finalized prior to approval of the preliminary design. The preliminary design may be incorporated into the Preliminary Public Improvement Construction Plans (PICP's), or processed separately, as necessary.
- Submission of a final design shall include all: construction details, signing and striping plans, and proposed construction phasing (if applicable). The final design shall be incorporated in to the Final PICP submittal.

The final approval of any platting application and/or Final PICP's will not occur until the final design plans for the roundabout are also ready for approval.

TABLE 1: ROUNDABOUT CATEGORIES

MULTI LANE ROUNDABOUTS	GENERAL USE DESCRIPTION	REFERENC E
4-Lane by 4-Lane Arterial	Residential/Commercial major arterial intersection	Figure 10
2-Lane by 4-Lane Arterial	Residential/Commercial greenfield development access to existing major arterials	Figure 11
2-Lane by 4-Lane with by-pass lane	Residential/Commercial greenfield development to existing major arterials with heavy right-turn from minor road entry	Figure 12
SINGLE LANE ROUNDABOUTS		
2-Lane by 2-Lane Arterial	Residential/Commercial greenfield development; Arterial-Arterial or Arterial-Collector	Figure 13
Collector	Residential/Commercial greenfield development; Collector-Collector or Collector Residential	Figure 14
Mini	Commercial retro-fit, 2-lane road w/o center lane to facilitate traffic processing and pedestrian safety in place of 4-way stop control or signal	Figure 15
Residential Compact	Residential Traffic Calming	Figure 16

B. General Design Criteria

1. Appropriate Roadways/Locations

Roundabouts should only be used where physical conditions, such as approach grades and adequate right of way, allow for proper entry alignment. Roundabouts are generally limited for use on a roadway with four or fewer through lanes, resulting in no more than two circulatory lanes. They are not appropriate where their use is expected to produce greater vehicle delay or significantly increased difficulty for pedestrians without the need for special accommodation measures. Selection of a roundabout intersection should be proposed and accepted for consideration at the conceptual level for a proposed development.

The design of the approach roadways must provide adequate visibility from a distance that will allow approaching drivers to see the roundabout under daytime and nighttime conditions. This decision sight distance (DSD) is the minimum distance required which will allow deceleration from the 85th percentile travel speed (or posted speed limit, whichever is greater) to the maximum allowable entry speed of 25 MPH (single lane) or 30 MPH (multilane) at the Point of Entry (POE) without exceeding a deceleration rate of 11.2 ft/s/s. The POE shall be considered the point of curvature of the entry curve (R1). The DSD shall be based on Avoidance Maneuver B from Table 3-4 of the AASHTO Green Book. The length of the maneuver shall be measured along the vehicle path(s) to the conflict point as shown on Figure 4.

2. Approach & Circulatory Speeds

The approaching roadway lanes should generally be shifted to the left of center of the proposed roundabout, producing a “left-loaded” entry design. This should be accomplished by flattening the exit curvature to the maximum extent possible, and/or realigning the entry lanes through the use of a chicane. This may, or may not incorporate shifting of the central island or approach roads to achieve the best left-loaded entry for the predominant entry movements. Approach alignments to the center or slightly right of center will not be acceptable, unless the fast path criteria and truck turning movements can be met without compromising other design criteria.

As a general rule, roundabouts may have three or four approaches. A fifth approach leg or driveway may be approved by variance, as long as it can be shown that the additional leg will not significantly degrade the operation or safety of the roundabout. Increasing the number of approach legs will generally require a larger inscribed diameter to accommodate the additional leg. A three-leg roundabout should be configured as a tee intersection to minimize fast right-turn movements. All approaches on a three-leg roundabout shall be left loaded to provide adequate slowing for the entry movements.

Approach roadways may be designed as:

- single-lane
- single-lane with a flare-out to provide an added entry lane
- partial right-turn bypass lane at the circulating roadway
- single-lane with a right-turn by-pass lane
- two lanes
- two lanes with a right-turn by-pass lane

The configuration selection shall be based on the turning movement volumes and pedestrian considerations. Right turn by-pass lanes should not be considered where significant conflicting pedestrian crossings are expected, unless special treatments such as rapid flashing beacons or HAWK (High intensity Activated crossWalk) type signals are proposed. Right-turn by-pass lanes shall not be considered unless the capacity analysis indicates one is necessary to meet level of service (LOS) requirements.

The approach roadway section is defined to include the length of roadway from the point where an approaching vehicle begins to decelerate, to the yield line, where the vehicles enter the inscribed circle (see Figure 1 for an explanation of the various roundabout elements). For design purposes, this section shall extend to the limits of the decision sight distance, as defined in Exhibit 3-4, Chapter 3, of the AASHTO Green Book, using the “Avoidance maneuver B: Stop on urban roadway” distance. The central island shall be visible from a minimum distance equal to the stopping sight distance both day and night (with standard street lighting).

Operating speed maximums are controlled by the “fast path” (FP) as noted in Figure 2. The fast path is the minimum radius of an arc that is 65 feet in length, fit to the fast path spline and measured along the vehicle path (not along the curb flowline). Increasing the inscribed diameter, coupled curves, landscaping, roadway narrowing,

and other forms of psychological speed reduction measures may be required where approach speeds are higher due to design constraints.

Design speed limitations and their respective radii through the roundabout are shown on Figures 2 & 3, included in section C – Specific / Geometric Design Elements, identified as R0, R1, R2, R3, R4 and R5. The maximum radius and respective speeds at various locations on the travel path through the roundabout are critical to the safe operation of the roundabout. Curb & gutter, splitter islands and the central island placement control the fastest vehicle path, but are not the same radii. In addition to the overall speed limitation for operation, the maximum speed differential between any two vehicles of the traveled path is 12 MPH to reduce the potential for rear-end type accidents for vehicles turning left or exiting. The fast path shall be modeled in accordance with methods described in NCHRP 572, Appendix G.

All alignment parameters, including sight distance restrictions for landscaping, shall be included in the preliminary design drawings. See Figure 4 for sight distance triangle restrictions.

3. Design Vehicle

All single-lane roundabouts shall be designed to allow single passenger cars, pickups, single unit (SU) trucks and fire trucks (B-40, BUS-45 AND WB-45) to proceed without requiring the use of the truck apron. For two-lane roundabouts, the design shall accommodate a WB-50 vehicle without the use of the truck apron. It is expected that larger trucks will require the use of the truck apron, especially on single-lane roundabouts. In addition to the aforementioned requirements, all roundabouts shall be designed to accommodate the passage of a WB-67 vehicle. In the determination of vehicular travel/turning paths, the gutter pans may not be considered as part of the traveled way, and vehicles shall not be proposed to utilize these areas while negotiating the roundabout. As such, the designer shall assume a two-foot (2') offset from the face of curb when defining acceptable truck paths.

The design of Mini roundabouts shall allow for longer trucks (B-40, BUS-45, WB-45, WB-50, and WB-67) to traverse the central and splitter islands. Therefore, the central and splitter islands on Mini roundabouts shall remain free of signage and other non-mountable obstructions.

In areas where high truck volumes exist or are anticipated, additional design accommodations may be required as determined by the Local Entity Engineer. Similarly, it may be necessary to model special vehicles through a roundabout that is located along a route that is, or may be, used for the transport of oversized equipment, such as, large transformers, wind turbine parts, heavy military equipment, manufactured housing, etc. Some of these delivery trailers have adjustable hitches or have steerable rear axles that will need to be considered in the design. If any, special delivery needs along the proposed route will need to be defined at the conceptual submittal stage. In all cases, the design vehicle shall be defined and accepted prior to preliminary design.

The adequacy of all roundabouts in regard to the design vehicle shall be evaluated using a Local Entity-approved truck turning software package to show the appropriate wheel paths for right, through, and left turn movements from each entry of the roundabout, and shall be submitted with preliminary design. Truck positioning on entry to a multi-lane roundabout may assume that the truck will occupy both entry lanes and utilize both circulatory lanes during the traverse of the roundabout. For all truck turning evaluations, the minimum vehicle speed shall be 10 miles per hour.

4. Pedestrian / Bicycles

All roundabouts shall be designed to allow pedestrian crossings whenever sidewalks are existing or planned. Pedestrian crossings shall be provided with appropriate pavement markings, as outlined in Figure 4. Supplemental signage may also be required for pedestrian crosswalks located along a school route, bordering a park or shopping area, or any other area where high pedestrian activity is expected. Crosswalk lighting shall be designed in accordance with the National Cooperative Highway Research Program publication 672 (NCHRP 672). The designer shall work with the local power provider to facilitate the necessary power connections. The light standard placement shall be a minimum of four feet (4') from the back of curb.

In areas of high potential for vehicle/pedestrian conflict, supplemental active warning devices, such as flashing beacons or LED supplemented signage, may be required. The warning devices may be activated either manually by the user or automatically by a Local Entity-approved detection / actuation technology.

Except in residential compact roundabouts or where otherwise precluded due to site constraints, all sidewalks and multi-use paths in the area of a roundabout shall be detached from the curb by a minimum distance of 10 feet.

If the roundabout is on a street with approaching bike lanes or on a roadway with planned bike lanes, the approach shall provide for a connection from the bike lane to the multi-use path, as illustrated on Figure 7. The intent is to allow the bicyclist the choice to either proceed through the roundabout as a vehicle, or exit the roadway prior to the roundabout onto the detached multi-use path. The on-street bike lane should terminate at the point where the bike lane exits from the roadway using a 40' taper as shown on Figure 7.

Figures 4 thru 9 provide design details for construction, signage, and pavement markings for pedestrians and bicyclists. Details of site-specific markings and signage shall be included with the preliminary design submittal for all proposed roundabouts.

5. Design Software

Local Entity-approved design software shall be used to ensure proper design and capacity for any new roundabouts. For Local Street or Minor Collector intersections where the 20-year projected link volumes are expected to be less than 500 AADT, a capacity analysis is not required unless the roundabout will experience high peak volumes for vehicles and/or pedestrians (such as near a school).

At the conceptual level, intersections with collector or higher roadway classifications shall be evaluated with the Roundabout Capacity Evaluation Spreadsheet 1A.1 and the 2010 Highway Capacity Manual methodology or RODEL/ARCADY. At the Preliminary Design level, all roundabout intersections will require analysis by methods detailed in current versions of: RODEL, ARCADY or VISSIM to analyze the roundabout for level of service (LOS) and queue concerns in relation to the Local Entity's Adequate Community Facilities (ACF) Ordinance. The City of Fort Collins may require SIDRA INTERSECTION software for roundabout evaluation. Designers should contact the Local Entity Engineer for guidance on required analysis and input parameters.

For roundabouts proposed at the intersections with Major Collector, Minor Arterial, or Major Arterial roadways, the use of RODEL or ARCADY analysis software is required for capacity analysis and evaluation of geometric design variables. The specific RODEL or ARCADY parameters shall be developed based on the recommendations of their respective instruction manuals. Additionally, VISSIM analysis may also be required for verification of the RODEL or ARCADY results. A lane use diagram showing origin-destination turning movement volumes will be a requirement of preliminary design review. For unbalanced entry and circulation modeling in multi-lane roundabouts, the analysis software chosen shall consider the key individual conflict zone as determined by the proposed geometry and striping.

The following guidance is given for the RODEL effective entry width parameter "E", assuming a striped roundabout entry:

A. Single-Lane Entry -

1. E shall be a **minimum** of 3.0m (9.84ft)
2. E shall be a **maximum** of 4.5m (14.76ft) if the approach feeds a single circulating lane
3. E shall be a **maximum** of 5.5m (18.05ft) if the single lane approach feeds 2 (or more) circulating lanes

B. Multi-Lane Entry -

1. The **minimum** lane width shall be 3.0m (9.84ft)
2. The **maximum** lane width shall be 4.0m (13.12ft)

Based on the above, a two-lane entry can be 6m - 8m (19.69ft – 26.25ft) wide

The Kimber roundabout capacity equations used in the RODEL and ARCADY analysis programs show capacity increases on a smooth curve related to input parameters that do not consider roadway striping. Where striping is proposed with the roundabout design, the E values must be input based on the effective width as detailed above and in the RODEL manual consisting of different lane width sizes. For example, if the measured design entry width E is 10m in the model, this represents three 3.33m lanes, not two 5m lanes as the entry width E exceeds the maximum lane width. The effective width should be set in the model to the maximum for two lanes at 8m even though the measured width is 10m.

If any lanes are designed wider than 4.0m in order to accommodate trucks, they should be considered to be 4.0m wide when summing the lane width to get E for use in RODEL. Usually, entry lanes have equal width, but a two-lane approach may have a 3.60m lane and a 5m lane, the latter made over-wide for trucks. For RODEL, the input would be $E = 3.6 + (4.0) = 7.6\text{m}$, not $E = 3.6 + (5.0) = 8.6\text{m}$

All preliminary designs shall be accompanied by AM and PM peak hour turning movement counts for existing and build-out conditions and traffic growth projections for both 10 and 20-year horizons. The RODEL or ARCADY output shall also be provided at this time, when required. Where the roundabout is near a school, shopping center or other major traffic generator, the peak hour for local traffic with the traffic generator fully developed shall be used and may be different from standard a.m. or p.m. peak times. In addition to the RODEL or ARCADY output file, a diagram graphically depicting the input parameters similar to that shown on Figure 1, shall be provided. The horizontal roundabout layout shall be provided to the Local Entity in CAD format that is compatible with Autodesk version 11.0 to allow for review of input parameters.

6. Utilities & Drainage

Design of underground and overhead utilities shall be included with the Preliminary Design. Design of water, sewer, and electric shall meet the appropriate Local Entity's standards, or the standards of any applicable special district. The placement of manholes and valve risers shall consider maintenance safety issues as well as their location relative to wheel path in order to minimize surface ride issues. Street lighting shall follow the Local Entity's standards for pole, light fixture and type of lighting. In general, lighting shall be designed to illuminate any pedestrians within the crosswalks without causing a backlighting effect. Lighting shall also be situated to help the driver identify the general shape of the intersection and to highlight conflict points or areas of entry and exit from a distance equal to, or greater than the stopping sight distance as identified in Figure 4.

Drainage design shall comply with the Local Entity's storm drainage standards. Roundabouts should be generally designed to slope away from the central and splitter islands with drainage inlets located on the outer curb line of the approach roadways and away from the pedestrian crossings. Inlets within the roundabout circulatory roadway shall be constructed with CDOT Type R inlets with sufficient capacity to limit the encroachment into the circulating area to a maximum depth of 4-inches for the 10-year event. Placement of any inlets shall also consider the vehicle's wheel path when traveling through the roundabout.

7. Landscaping

Landscaping is an important part of the design, especially in the central island, as it provides visual awareness of the roundabout. Landscaping designs must consider pedestrian and vehicle safety, providing year-round amenities for the roundabout users without causing sight distance problems. This is especially important on approaches to pedestrian crossings.

All final designs shall include a landscaping design sheet identifying plant types, height from the top of the mature plant to the roadway surface (including the height of planter area), and the minimum pruning height for the lower branches of any trees to be planted. See Figures 4 and 6 for areas where plant height is restricted for sight distance reasons. Within the central island, but outside of the required stopping sight distance line, the use of larger plant materials is encouraged to improve the driver's perception of the roundabout location and shape. Care should be taken to avoid distracting displays, such as signs, intricate sculptures, animated items, glare from lighting, or any other features that could increase the potential for driver distraction. In no case should anything be placed within the central island which would encourage pedestrians to access the central island.

8. Other

Other design criteria include but are not limited to:

- The departure width of the roundabout shall be no narrower than the width of the circulatory roadway and include a transition to the departure lane width cross-section, exclusive of on-street parking and bike lanes (Figure 7). The roadway shall then taper out to its full width (bike-lane or parking) as shown on Figure 6.
- Transit stops should be located downstream of the roundabout, clear of the exit area, and a minimum of 50 feet downstream of the bicycle re-entry ramp (Figure 7). The transit stops shall be built with a LCUASS standard pullout or combined with the on-street parking area.

All unusual or location-specific design issues shall be resolved prior to the submission of final design plans.

C. Specific / Geometric Design Elements

1. Critical Geometry

The roundabout advantage is its ability to move large volumes of traffic at a slow deliberate rate of speed that processes the necessary turning movements into the through movements with less potential for high speed accidents. The efficient use of the intersection area is created and controlled by the geometry of the roundabout and specifically the approach road entry. Roundabout design is a balance between competing objectives and thus requires a context sensitive approach to meet the design objectives. The design guidance described below is a standardized approach intended to produce a reasonable, first-cut horizontal design. Intersections with specific rights-of-way constraints or traffic needs will have to be addressed with a context sensitive approach.

2. Roundabout Design Approach

Once a preliminary roundabout lane configuration has been developed based on projected traffic turning movements and capacity evaluations, the designer should develop a rough horizontal layout by using the applicable Figures in this manual as a guide.

The approach roadway design elements include curb alignment, median width and transition, approach flare, crosswalk location, horizontal and vertical alignment of the approach lane(s), intersection and stopping sight distance calculations, approach speed, fast path radii, and other associated elements identified in Figures 1 through 7. Minimum / maximum design standards are as follows:

Fast Path (FP)		Single Lane (ICD 115-155)		Multi-lane (ICD 150 - 215)	
Designation	Movement	FP Radius Range (ft)	FP Max Speed	FP Radius Range (ft)	FP Max Speed
R1	Entry	120 – 160	25	175-275	30
R2	Circulating	90 – 115	25	175-215	25
R4	Left Minimum	40-60	15	70	15
R5	Right Turn	120 -160	25	175-215	25

*R4 has a minimum requirement to reduce rear end accidents caused by excessive speed differential

Note – radii are given as a range for various superelevation rates from 0% to 4%, positive for R1, R3 & R5, and negative for R2 and R4. Calculations for each specific roadway segment and corresponding cross slope shall follow the AASHTO Green Book.

Maximum vertical grade (approach) 2% for 200' on minor and principal arterials
4% for 100' on minor and major collectors
4% for 50' on local streets

Approach Decision Sight Distance 400' for 25 MPH or less
(“DSD” on Figure 4 - measured from 490' for 30 MPH
the yield line) 596' for 35 MPH
690' for 40 MPH
800' for 45 MPH
910' for 50 MPH

Note – Approach Decision Sight Distance, DSD, is the distance at which the driver is aware of the change in alignment caused specifically by the roundabout. If the required DSD is not available due to topographic limitations, advance warning signs shall be required. Vertical alignment must be checked as well as horizontal alignment for restrictions to DSD.

Minimum Approach Tangent 300' on principal arterial
(approach centerline to yield line) 200' on minor arterial
100' on all collectors
50' on local access

Min. distance to nearest access (distance from splitter island)	600' on principal arterial 300' on minor arterial 100' on all collectors 30' on local access
--	---

3. Circulating Roadway

The circulating roadway, that portion of the roundabout between the central island and the inscribed circle diameter (ICD), is the portion of the roadway used by vehicular traffic. In Loveland (city limits only), the circulating roadway within all proposed roundabouts shall be concrete pavement, unless otherwise approved by the Local Entity Engineer. The ICD of the roundabout, which encloses the circulating roadway, shall be large enough to accommodate all road users without exceeding the fast path maximum radii. Generally, the design of the inscribed circle will be from 140' to 215' for multilane roundabouts, and from 90' to 155' for single lane roundabouts and 50' to 90' for Mini and Residential Compact roundabouts. The outside edge of the circulating roadway is within and generally the same size as the inscribed circle.

The circulating roadway shall be from 1.0 to 1.2 times the maximum approach roadway width at the widest entry to the roundabout. Super-elevation for the circulatory road should generally be no greater than 2%, although a super-elevation of up to 4% may be approved if conditions warrant. Adverse super elevation is preferred for the circulatory road as it provides a smoother transition for motorists, better drainage, and keeps circulating speeds to an acceptable level.

Roundabouts may be designed and built in stages, with the initial size of the inscribed circle large enough for a multilane roundabout, with an oversized central island that restricts the circulating roadway to one lane. In this case, it is likely that an oversized truck apron will be needed.

Dedicated bypass lanes should be avoided if possible, due to the difficulty for pedestrians to cross three roadway segments instead of the usual two in other roundabouts. If the capacity analysis with RODEL indicates that the existing and shorter range projected volumes will operate at LOS D or better, the roundabout should be built without a bypass. If the 20 year projected volumes show the need for a bypass, adequate right of way shall be included to accommodate the future expansion and the bypass will be built when the operating LOS exceeds level C.

4. Sight Distance

Stopping Sight Distance (SSD) is the distance between a roadway obstruction and the approaching driver, measured along the vehicle path. It is used to assess safety for vehicle to vehicle, vehicle to pedestrian or bicycle, and vehicle to other object hazards. Every conflict point at the intersection must be checked, based on fast path vehicle speed near the conflict area for obstructions of the required visibility area – see Figure 4.

SSD for the approach and yield at the roundabout shall be based on current AASHTO Green Book standards for urban roadways.

5. Splitter Islands

Splitter islands are necessary to provide proper deflection of vehicular traffic for speed control and to provide pedestrian refuge areas. For multi-lane roundabout entries, the alignment of the splitter island curb shall incorporate an extension of the splitter island that is tangential to the outside flow line of the central island (Figure 1). For arterial roundabouts, splitter islands shall be a minimum of 150' in length (300' preferred). See Figures for minimum splitter island lengths for other types of roundabouts.

Splitter islands shall be designed with a minimum 6' x 6' (8' x 8' preferred) pedestrian refuge. Crosswalks shall be located 25' from the yield line for all roundabouts unless otherwise approved by the Local Entity Engineer (Figure 5). Crosswalks shall also be designed to be radial to the traveled roadway in order to improve visibility for pedestrians.

The splitter island curb layout shall be designed in accordance with Figure 6.

The central island diameter for a multilane roundabout shall be determined in a manner that assures that the deflection for entering vehicles will result in a design that meets the maximum fast path requirements. Generally, the central island diameter will fall between 115' and 175' for a multilane roundabout and between 95' and 135' for single lane roundabouts and 35' to 75' for Mini roundabouts.

Truck aprons are required and may not exceed 5% superelevation. They shall be constructed of concrete and be contrasting in texture and color from the surrounding roadway, easy to maintain, and able to withstand the loadings of turning trucks (i.e. minimum 6" thick, decorative, contrasting colored concrete, etc.). In no case should a truck apron resemble a sidewalk. Brick, cobblestone or other individually placed paving materials may be considered when set on an adequately designed concrete supporting shelf. Additionally, truck aprons shall be provided with a monolithic 4" mountable perimeter curb that is back-sloped at a 45 degree angle with a rounded top. See Figure 5 for additional truck apron design information.

Elevation drawings of the central island shall be included with the preliminary plans. Except for Mini and Residential Compact roundabouts, the central island, exclusive of the truck apron and any sight distance restricted areas, shall be a minimum of 2' above the surrounding roadway, and shall be of contrasting texture and colors to the roadway and surrounding areas. The interior surfacing of the central island shall also be designed for low maintenance, discouraging the use of sod or other high maintenance plantings/materials.

7. Signing & Marking

All signs and pavement markings shall conform to the current *Manual on Uniform Traffic Control Devices* (MUTCD) as amended, and by these design standards.

1. **Signing** - See Figure 9 for sign locations.
 - Yield signs shall be placed on the right side of the approach roadway, at the point where vehicles are required to yield when entering the roundabout. With the exception of Mini and Residential Compact roundabouts, yield signing will also be required in the splitter islands. Supplemental "YIELD" pavement markings may also be required where field observation warrants.
 - Lane assignment signs, depicting the lanes maneuvering around the roundabout, shall be provided on all multi-lane approaches (Figure 8). This requirement shall also be applied to single-lane approaches with auxiliary turn lanes.
 - Street name signs with minimum 8" lettering shall be placed on the splitter islands and oriented toward traffic on the circulatory roadway (Figure 8).
 - Flag type guide signs, indicating the correct directional exit for service, recreational and cultural destinations are required for major destination routes.
 - Advanced guide signs (Figure 9) shall be required for roundabouts with two or more circulating lanes or five or more legs.
 - Pedestrian crossing signage shall be required where high pedestrian usage is expected, or as otherwise determined by the City.
2. **Marking** – Pavement markings shall consist of pre-formed, hot-applied thermoplastic material. All linear pavement markings, including crosswalks, shall be grooved in using approved grinding process after the concrete has cured and installed even with the surface of concrete paving. All pavement markings can be installed directly on top mat of asphalt without being recessed. Where installed on concrete paving, all markings (lines, symbols, etc.) shall be outlined in black for increased visibility. Use CDOT specifications, section 627.08 (7a) for inlaid lines, symbols will not be inlaid. See Figures 10-15 for typical pavement marking types and locations.
 - Lane use pavement markings, including arrows and solid or dashed lines shall be used on all multilane roundabouts. See Figure 5 for their correct spacing and placement.

- Lane use pavement markings, including arrows and solid or dashed lines shall be used on all multilane roundabouts. See Figure 5 for their correct spacing and placement.
- Yield lines and “YIELD” pavement markings shall be used to mark the location at which drivers must yield to circulating traffic. The yield lines shall be curved along the outline of the circulatory roadway and shall be oriented toward approaching drivers as depicted on Figures 10-15. Placement and orientation of “YIELD” pavement markings will also be required as indicated on Figure 5. “Shark’s Teeth” type yield markings will not be permitted.
- Yellow edge lines shall be placed along the left edge of the approach roadway and along the edge of the splitter islands. For multilane roundabouts, white edge lines are required along the right side of the splitter island outlining the circulating roadway.
- Pedestrian crossings shall be marked with “Denver” or “Continental” style markings, consisting of 1.5’ x 9’ bars located in a manner that avoids the projected wheel path.
- Retroreflective raised pavement markers (RRPM) may be required on the central island and splitter island curbs where sight distance and/or other concerns indicate that additional warning is necessary for improved nighttime operational safety.

8. Landscaping Design Elements

In general, landscaping and design elements shall:

- Be aesthetically pleasing
- Fit within the context of the surrounding area
- Not create a distraction for drivers
- Not interfere with pedestrian safety
- Not attract pedestrians into the central island

Splitter islands shall either be hardscape or contain low level vegetation with a maximum height at maturity, of 30” above the roadway (Figure 6).

In order to reduce approach speeds, and with the exception of Residential Compact and Mini roundabouts; the central island shall contain vertical features that are visible to approaching traffic under daylight and nighttime conditions. All vertical features, however, shall be located outside of the stopping sight distance restriction area.

New roundabouts with landscaping shall be subject to a maintenance agreement with the local homeowners Association (HOA), providing for maintenance of all proposed landscaping. In the alternative, guaranteed funding for maintenance of the landscaping by other private organizations such as Metro Districts, Property Management Agencies, etc., may be acceptable. Retrofit roundabouts shall have low-maintenance landscaping or a maintenance agreement similar to new roundabouts.

D. Definitions

AASHTO Green Book – The current version of the American Association of State Highway and Transportation Officials publication “A Policy on Geometric Design of Streets”.

Central Island - the raised area in the center of a roundabout around which traffic circulates.

Circulating Volume -the total vehicular volume on the circulatory roadway immediately prior to an exit, measured over a specified period of time.

Circulatory Roadway – the roadway portion of a roundabout which circles the central island.

Circulatory Roadway Width - the distance between the outer edge striping of the circulatory roadway and the outer margin or lip of gutter of the central island, exclusive of aprons.

Deflection - the change in trajectory of a vehicle imposed by geometric features of the roadway.

Departure Width - the downstream width of the roadway used by vehicles departing the roundabout.

Design Vehicle - the largest vehicle that can reasonably be anticipated to use a facility.

Entry Flare - the widening of an approach upstream of the yield line in order to provide additional capacity.

Entry Path Radius (R1) - the minimum arc radius, fitted to the fast path, that occurs prior to the yield line (See Figures 2 & 3).

Entry Radius - the minimum radius of curvature of the outside (right) edge stripe, or lip of gutter, of the roundabout entry.

Entry Speed - the speed of a vehicle as it crosses the yield line.

Entry Width - the width of the roundabout approach where it meets the inscribed circle, measured perpendicularly from the right edge of the entry to the point of intersection of the left edge line and the inscribed circle (see Figure 1).

Exit Path Radius (R3) - the minimum arc radius, along the fast path, that extends from the roundabout exit (see Figures 2 & 3).

Exit Width - the width of a roundabout exit where it meets the inscribed circle, measured perpendicularly from the right edge of the exit to the point of intersection of the left edge line and the inscribed circle (see Figure 1).

Fast Path (FP) - a hand or spline-drawn representation of a vehicle's path through a roundabout which would allow the least deflection and thus, the highest travel speed given the geometric constraints. The method of determining the FP is detailed in NCHRP Publication 572, with further clarification available in Appendix G of that Publication.

Fast Path Radius - the minimum radius on the fastest through path around the central island measured 5' from any vertical face and 3' from center striping, as shown on Figures 2 & 3.

Inscribed Circle - used to define the size of a roundabout, it is the diameter of the largest circle that can be fit within the outer edges of the circulating roadway.

Local Entity Engineer - The Engineering Division Manager, City Engineer, or another Local Entity representative authorized to act on behalf of the Local Entity.

Mini-Roundabout - a small, retrofit roundabout intended process traffic volumes greater than 3500 AADT combined intersection traffic, which is intended to fit into locations with significant right-of-way constraints.

Multilane Roundabout - a roundabout that has a circulatory roadway that can accommodate at least 2 vehicles traveling side-by-side.

Partial Right-Turn Bypass Lane - a channelized right-turn lane that does not share the same entrance to the roundabout as the other entering lanes but yields to exiting vehicles due to the lack of an additional downstream merge lane.

Residential Compact Roundabout - a new construction, residential roundabout intended for traffic calming in situations with less than 3500 AADT combined intersection traffic.

Right-Turn Bypass Lane - a lane provided adjacent to, but separate from, the circulatory roadway, that allows right-turning vehicles to bypass the roundabout. Also known as a right-turn slip lane, this lane must be able to accommodate the design vehicle.

Roundabout - an intersection with 3 or more approach legs, generally circular in shape where continuous flow of traffic is facilitated through the use of yielded entry and defined lane use.

Sight Triangle - an area required to be free of obstructions in order to ensure visibility between conflicting movements.

Single-Lane Roundabout - a roundabout that has one circulatory lane.

Splitter Island - a raised area on an approach designed to separate entering and exiting traffic, deflect and slow entering traffic, and provide a refuge area for pedestrians crossing the approach.

Stopping Sight Distance - the distance, measured along the centerline of travel, along a roadway that is required for a driver to perceive an object in the roadway, react, and brake to a complete stop prior to reaching that object.

Truck Apron – a raised, colored and/or textured concrete surface, adjacent to the central island curbing, that is designed to allow large vehicles to proceed through the roundabout with their rear wheels leaving the circulating roadway and riding onto the apron area.

Two-Stage Crossing - a process in which pedestrians cross a roadway by crossing one direction of traffic at a time, waiting in a pedestrian refuge between the two traffic streams if necessary before completing the crossing.

ROUNDAABOUT TERMINOLOGY
(Rodel Symbology in Parenthesis)

See Rodel U.S. Manual for
input parameter description.

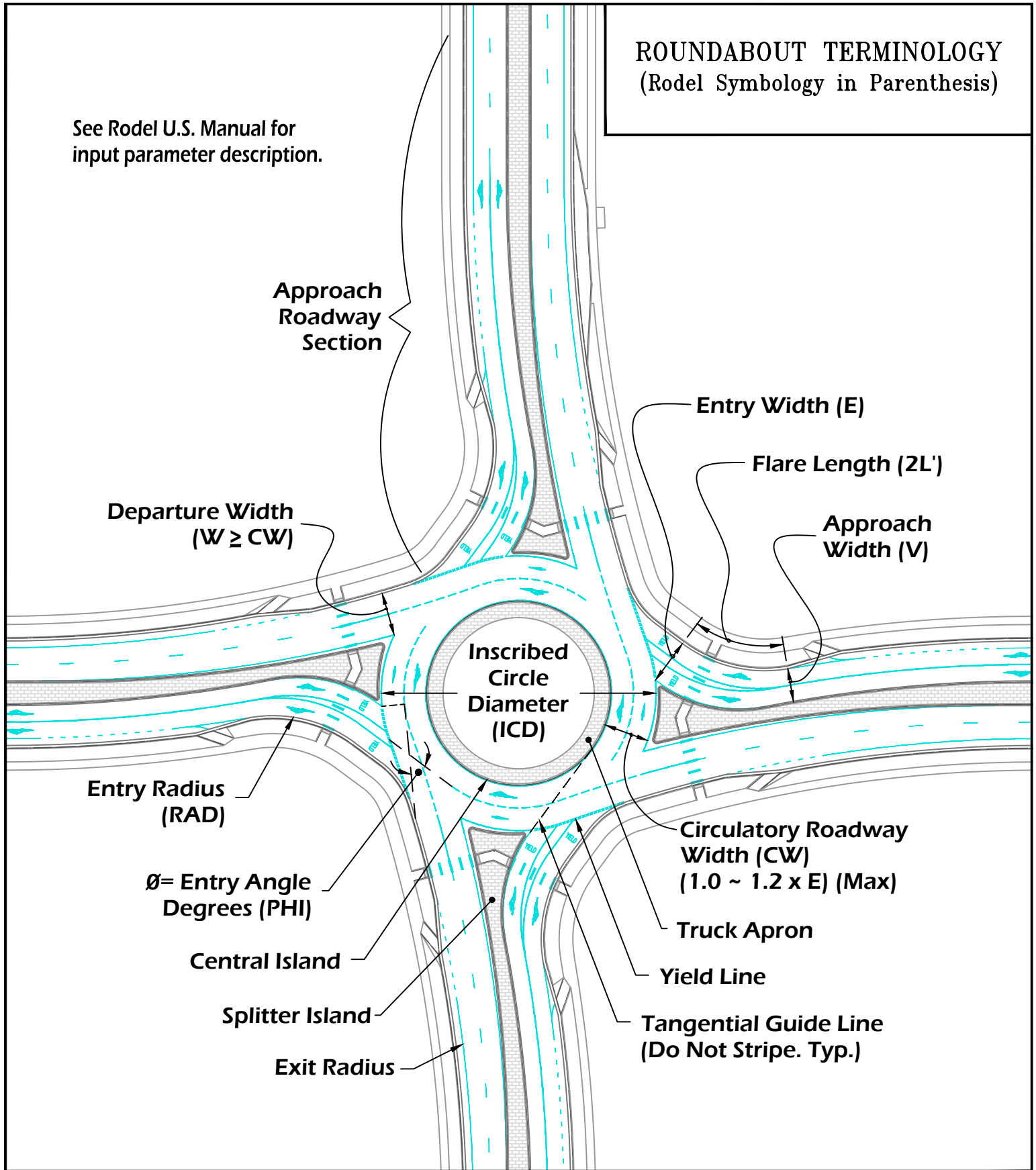

4 LANE/4 LANE ROUNDAABOUT DESIGN



CITY OF LOVELAND
PUBLIC WORKS
DEPARTMENT

DETAIL
DRAWING

APPROVED: JTK
DATE: 3/14/16
DRAWN BY: SRA

FIGURE
1

**FAST PATH DELINEATION
FOR MULTI-LANE
ROUNDAABOUT**

Draw CAD spline lines per the guidance described in NCHRP 572 Appendix G & Section 6 of NCHRP 672.

The maximum speed differential between two conflicting fast path movements should be no greater than 15 mph.

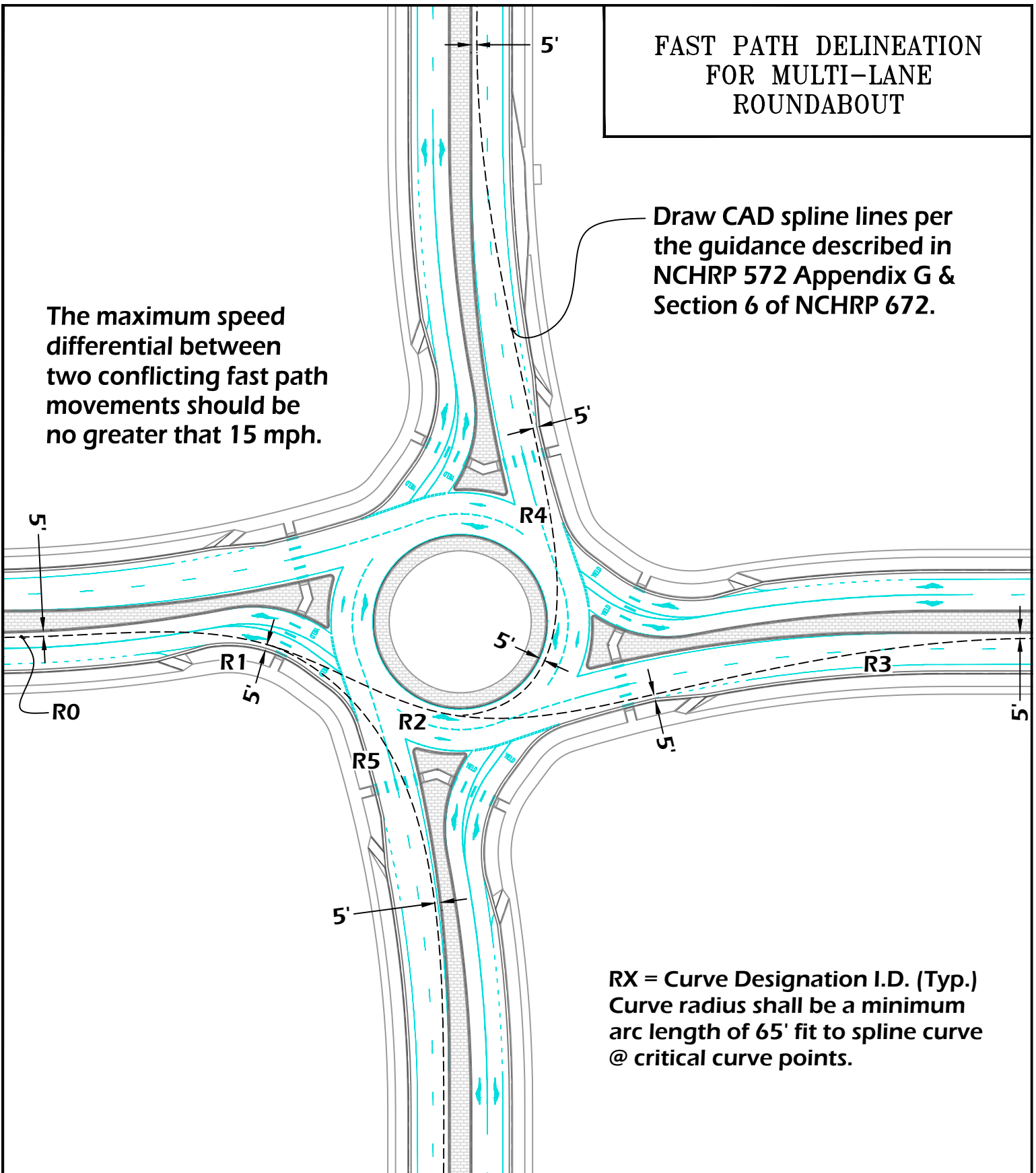

**RX = Curve Designation I.D. (Typ.)
Curve radius shall be a minimum
arc length of 65' fit to spline curve
@ critical curve points.**

4 LANE/4 LANE ROUNDAABOUT DESIGN



**CITY OF LOVELAND
PUBLIC WORKS
DEPARTMENT**

**DETAIL
DRAWING**

APPROVED: JTK
DATE: 3/14/16
DRAWN BY: SRA

**FIGURE
2**

**FAST PATH DELINEATION
FOR SINGLE-LANE
ROUNDBABOUT ENTRY**

The maximum speed differential between two conflicting fast path movements should be no greater than 15 mph.

Draw CAD spline lines per the guidance described in NCHRP 572 Appendix G & Section 6 of NCHRP 672.

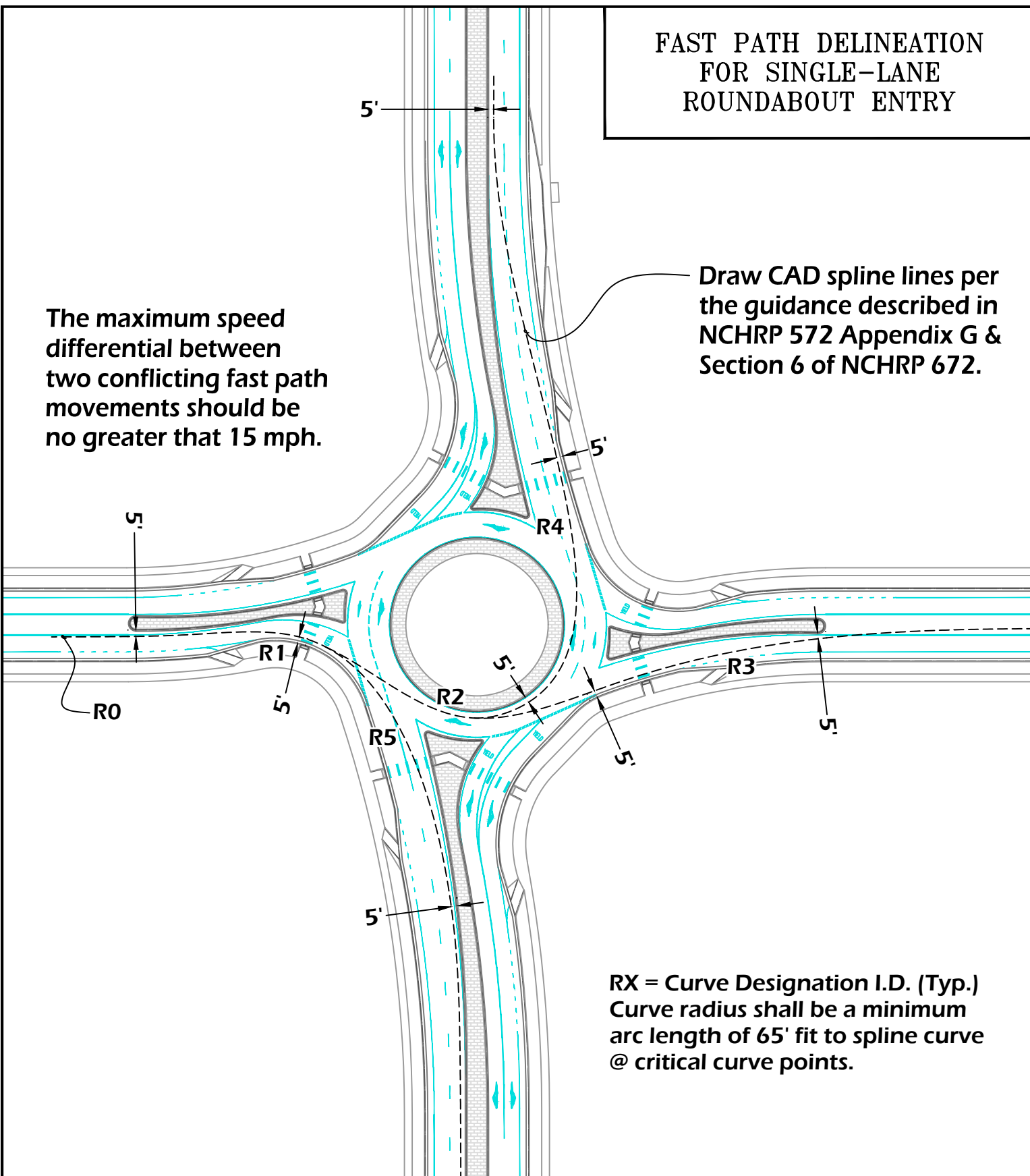

RX = Curve Designation I.D. (Typ.)
Curve radius shall be a minimum arc length of 65' fit to spline curve @ critical curve points.

2 LANE/4 LANE ROUNDBABOUT DESIGN



CITY OF LOVELAND
PUBLIC WORKS
DEPARTMENT

DETAIL
DRAWING

APPROVED: JTK
DATE: 3/14/16
DRAWN BY: SRA

FIGURE
3

**DECISION SIGHT DISTANCE
STOPPING SIGHT DISTANCE &
INTERSECTION SIGHT DISTANCE
(DSD, SSD & ISD)**

Typical, one approach shown,
Restrictions apply to all approaches.
See Section C. 1 & 3 for distances.

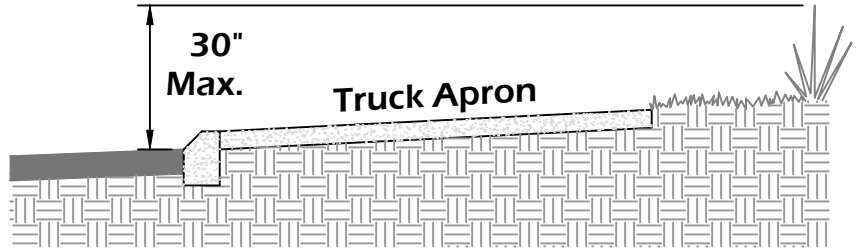

Maximum mature landscape
height in restricted sight areas.

Notes:

Decision Sight Distance (DSD) Intersection Sight Distance (ISD) and Stopping Sight Distance (SSD) must be checked for horizontal and vertical alignment.

DSD, ISD & SSD are measured along vehicle path.

SSD for pedestrians measured to a point 6' behind curb.

Conflict Point = X

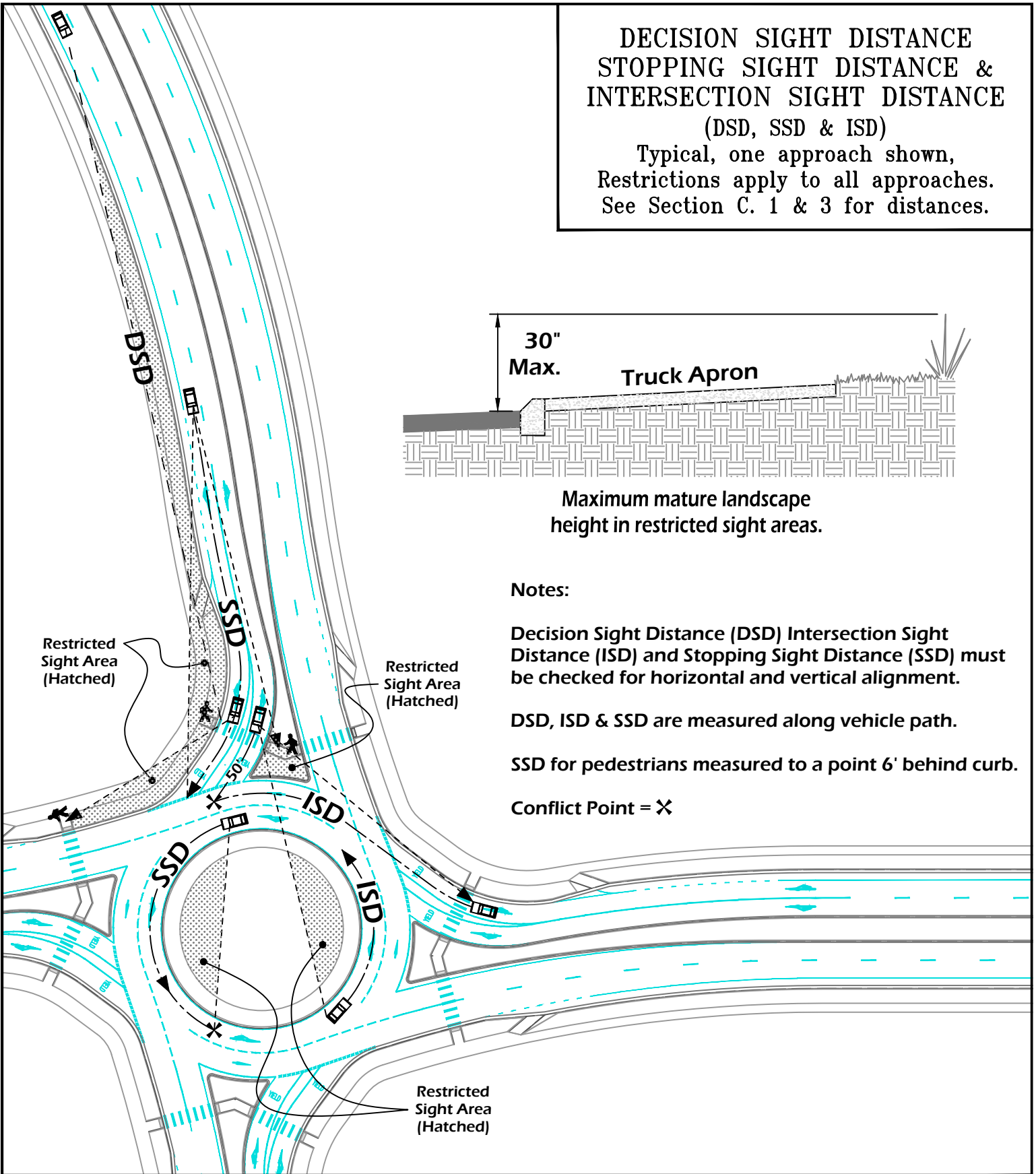

4 LANE/4 LANE ROUNDABOUT DESIGN



CITY OF LOVELAND
PUBLIC WORKS
DEPARTMENT

DETAIL
DRAWING

APPROVED: JTK
DATE: 3/14/16
DRAWN BY: SRA

FIGURE
4

CONSTRUCTION DETAILS

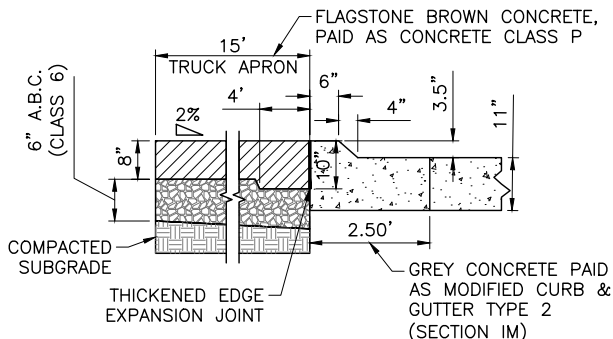

A - A Typical Truck Apron Detail

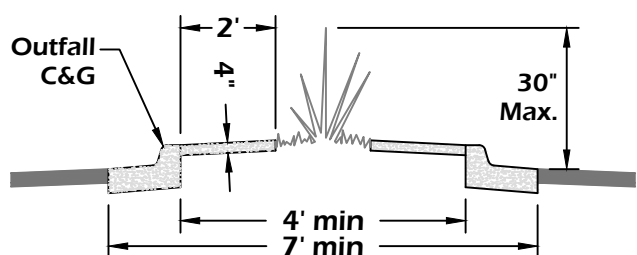

B-B Typical Splitter Island Detail

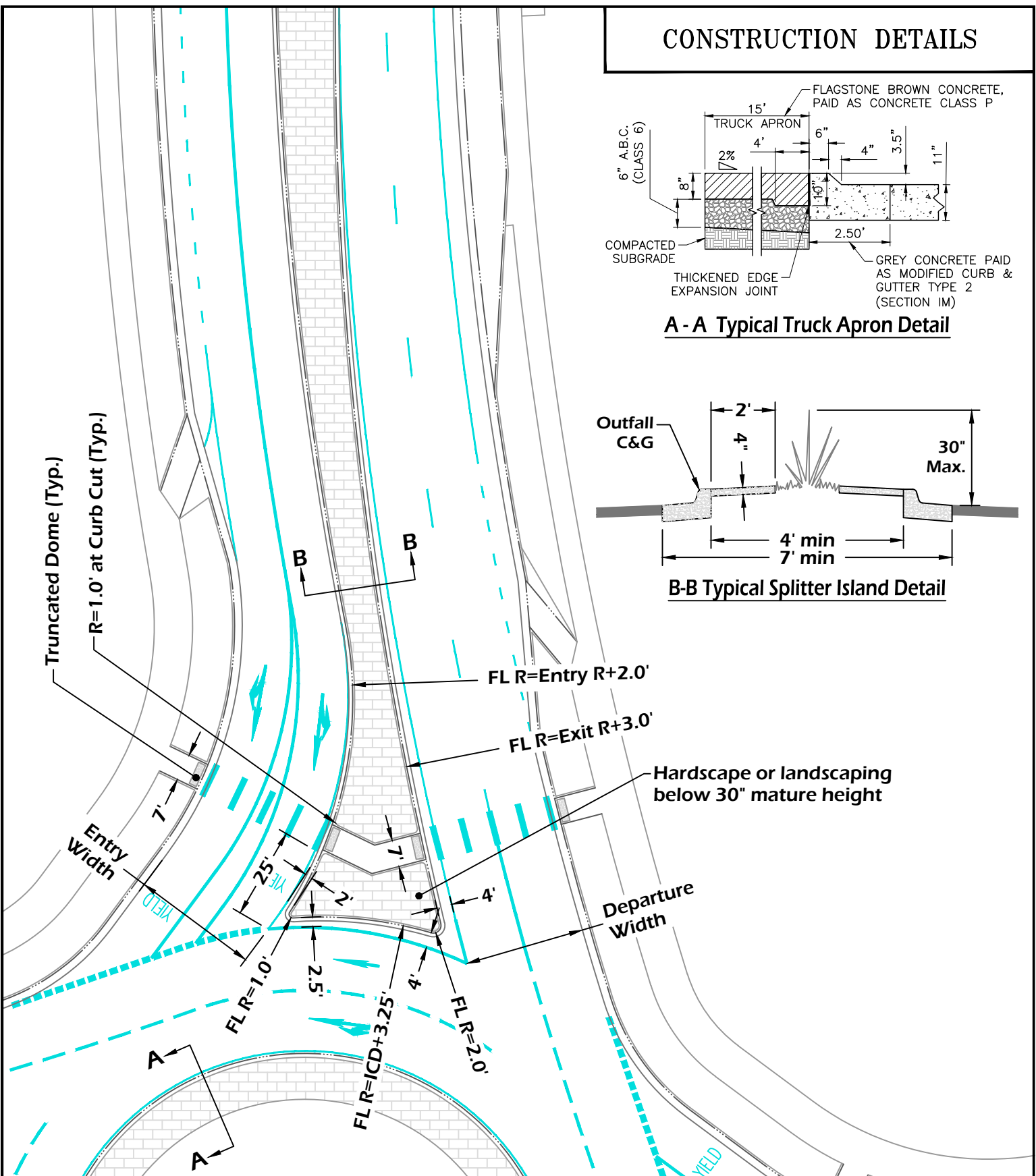

4 LANE/4 LANE ROUNDABOUT DESIGN



CITY OF LOVELAND
PUBLIC WORKS
DEPARTMENT

DETAIL
DRAWING

APPROVED: JTK
DATE: 8/1/21
DRAWN BY: SRA/NAB

FIGURE
5

CONSTRUCTION DETAILS

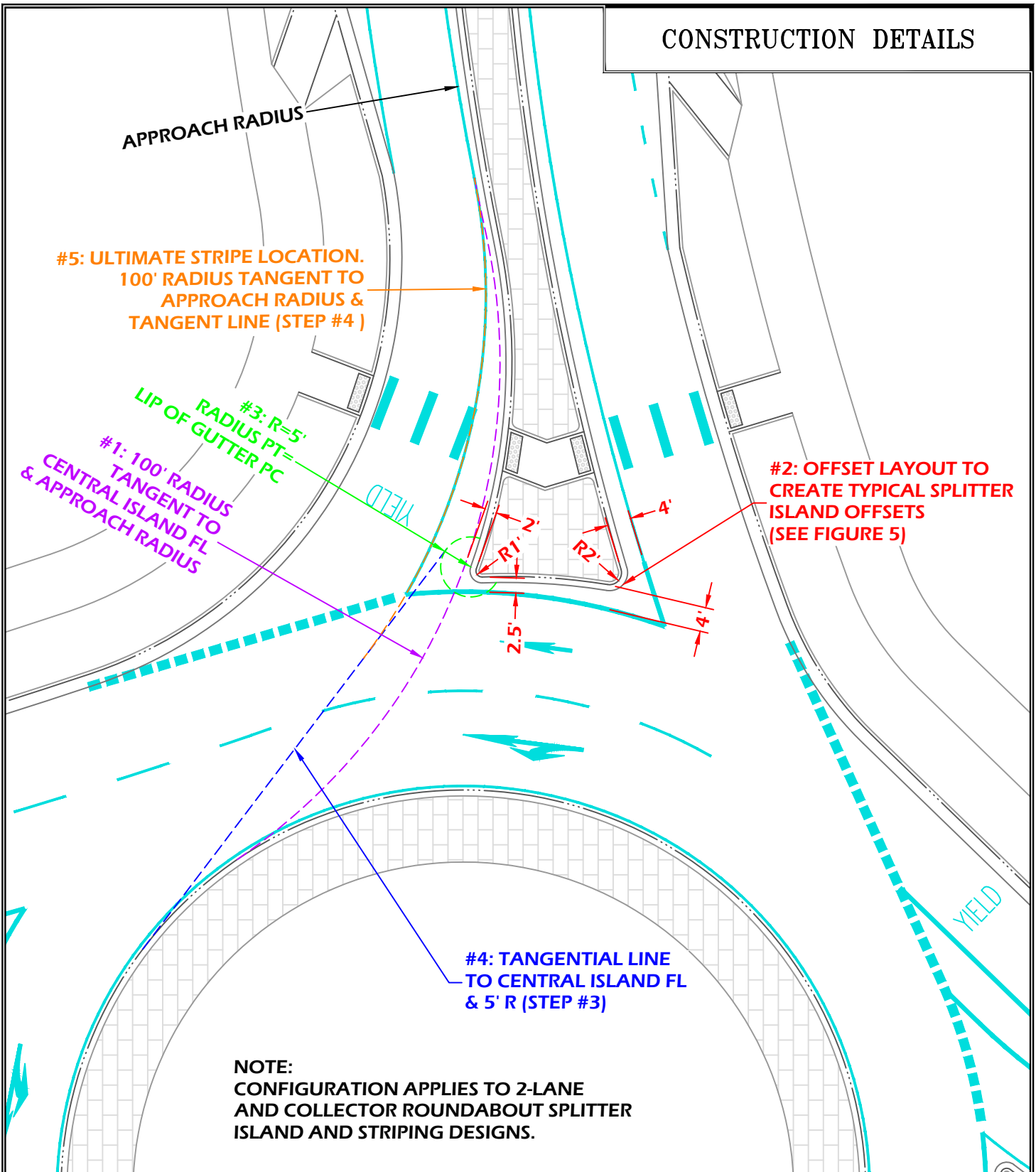

2 LANE LANE SPLITTER ISLAND DESIGN



CITY OF LOVELAND
PUBLIC WORKS
DEPARTMENT

DETAIL
DRAWING

APPROVED: JTK
DATE: 4/19/12
DRAWN BY: SRA

FIGURE
6

BICYCLE PATH AND RAMP DETAIL

Notes:

1. If bicyclist does not use multi-use path, cyclist is encouraged to become a vehicle and take full lane.
2. Multi-use paths will not be included in mini and residential compact designs. Cyclist shall become a vehicle under these designs.

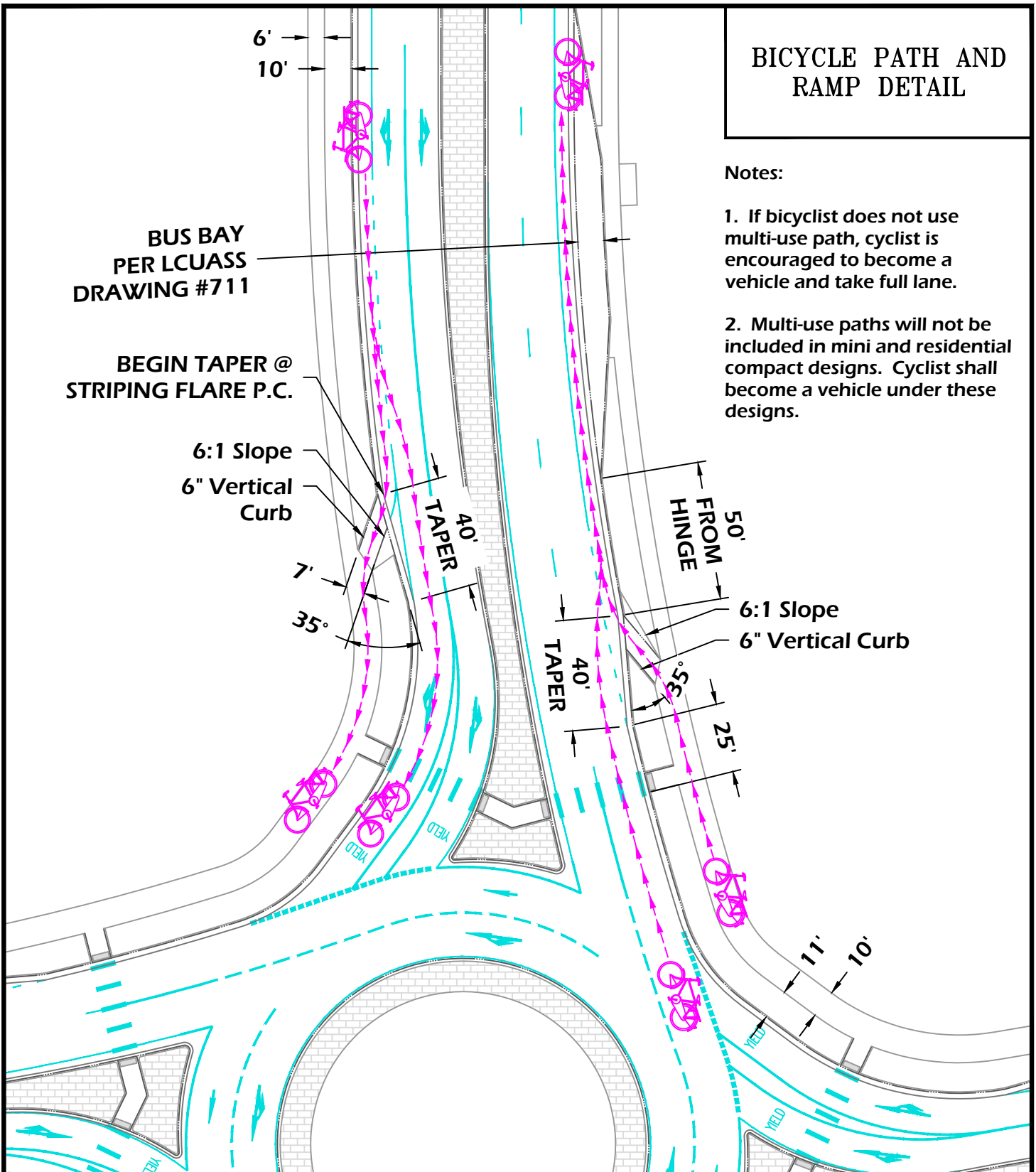

4 LANE/4 LANE ROUNDABOUT DESIGN



CITY OF LOVELAND
PUBLIC WORKS
DEPARTMENT

DETAIL
DRAWING

APPROVED: JTK
DATE: 3//14/16
DRAWN BY: SRA

FIGURE
7

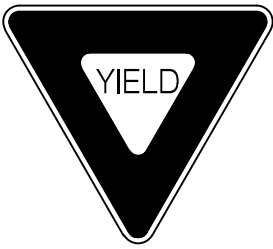

R1-2
36" x 36" x 36" (A)
(Red on White)

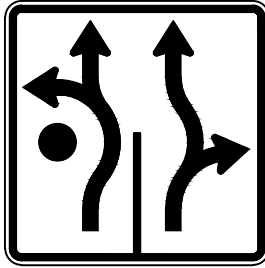

R3-8
36" x 36" (E) **
(Black on White)

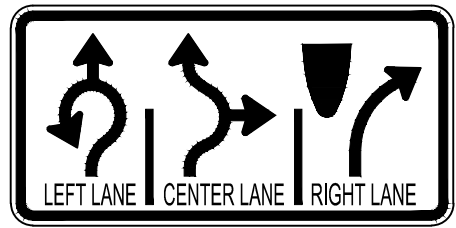

R3-8a
48" x 30" (E) **
(Black on White)

**MAY BE REQUIRED AT MULTIPLE LOCATIONS.



R6-4b (Reduced)
36" x 12" (B)
(Black on White)

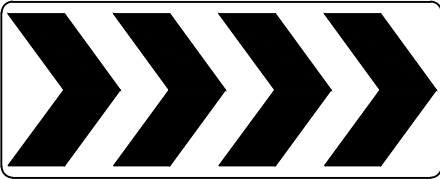

R6-4b
60" x 24" (B)
(Black on White)



R3-7R
30" x 30" (F)
(Black on White)

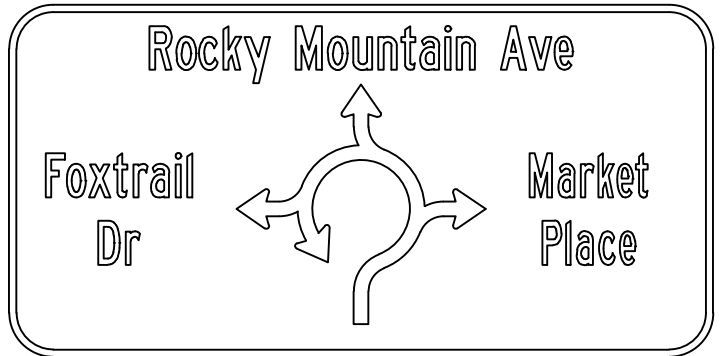

D1-5
48" x 96" (G)
(White on Green)

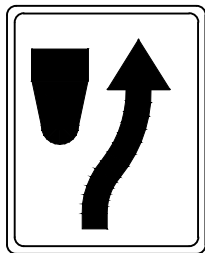

R4-7
24" x 30" (C)
(Black on White)

See the FHWA Roundabout Guidelines and the MUTCD for additional signing details.

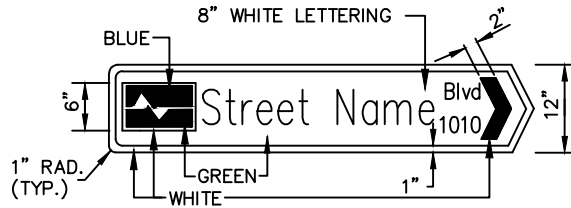

D1-1, Street Name Detail Sign
Loveland Only (H)
60" x 12"

This street name sign should only be used on Urban Roundabouts, mounted directly to sign post with rivets and nylon washers; 4 each per installation. End of blank is cut to match angle of chevron, retaining 1" white border.



W11-2a
30" x 30" (D) *
(Black on Yellow)

*OPTIONAL AS DIRECTED BY LOCAL ENTITY ENGINEER.



W16-7P
24" x 12"
Black on Yellow

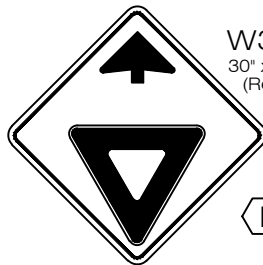

W3-2
30" x 30" (I)
(Red, Black, White on Yellow)

YIELD AT ROUNDABOUT
30" x 12"
(Black on Yellow)



R3-17
24" x 18" (J)
(White on Black)
R3-17bP
24" x 8"
(Black on White)

(SEE FIGURES 9A AND 9B FOR SIGN PLACEMENT)

ROUNDBOUT DESIGN STANDARD SIGNING



CITY OF LOVELAND
PUBLIC WORKS
DEPARTMENT

DETAIL
DRAWING

APPROVED: JTK
DATE: 8/19/19
DRAWN BY: SRA/NAB

FIGURE
8

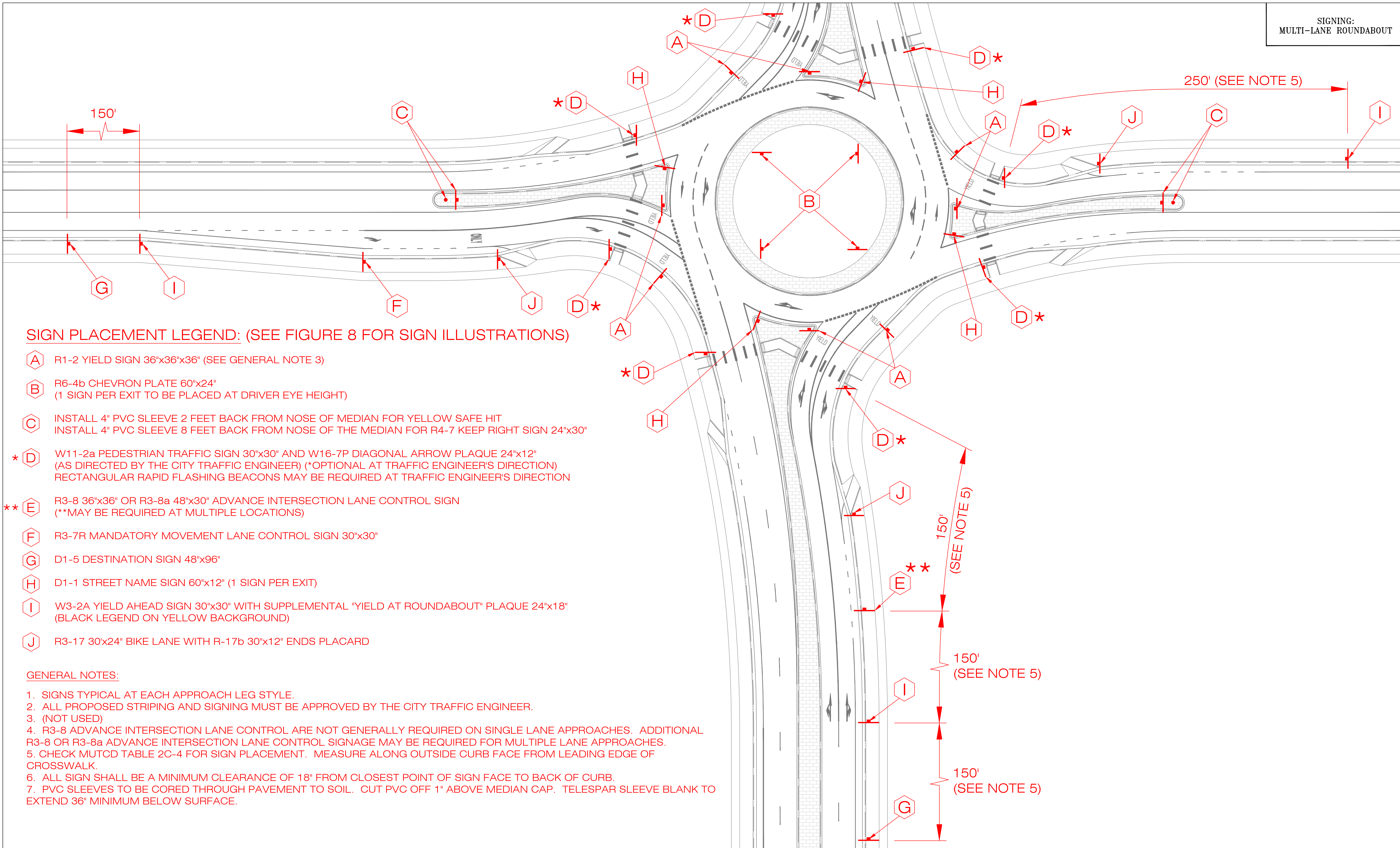

SIGN PLACEMENT LEGEND: (SEE FIGURE 8 FOR SIGN ILLUSTRATIONS)

- A** R1-2 YIELD SIGN 36"x36"x36" (SEE GENERAL NOTE 3)
- B** R6-4b CHEVRON PLATE 60"x24"
(1 SIGN PER EXIT TO BE PLACED AT DRIVER EYE HEIGHT)
- C** INSTALL 4" PVC SLEEVE 2 FEET BACK FROM NOSE OF MEDIAN FOR YELLOW SAFE HIT
INSTALL 4" PVC SLEEVE 8 FEET BACK FROM NOSE OF THE MEDIAN FOR R4-7 KEEP RIGHT SIGN 24"x30"
- *D** W11-2a PEDESTRIAN TRAFFIC SIGN 30"x30" AND W16-7P DIAGONAL ARROW PLAQUE 24"x12"
(AS DIRECTED BY THE CITY TRAFFIC ENGINEER) (*OPTIONAL AT TRAFFIC ENGINEER'S DIRECTION)
RECTANGULAR RAPID FLASHING BEACONS MAY BE REQUIRED AT TRAFFIC ENGINEER'S DIRECTION
- **E** R3-8 36"x36" OR R3-8a 48"x30" ADVANCE INTERSECTION LANE CONTROL SIGN
(**MAY BE REQUIRED AT MULTIPLE LOCATIONS)
- F** R3-7R MANDATORY MOVEMENT LANE CONTROL SIGN 30"x30"
- G** D1-5 DESTINATION SIGN 48"x96"
- H** D1-1 STREET NAME SIGN 60"x12" (1 SIGN PER EXIT)
- I** W3-2A YIELD AHEAD SIGN 30"x30" WITH SUPPLEMENTAL "YIELD AT ROUNDABOUT" PLAQUE 24"x18"
(BLACK LEGEND ON YELLOW BACKGROUND)
- J** R3-17 30"x24" BIKE LANE WITH R-17b 30"x12" ENDS PLACARD

GENERAL NOTES:

1. SIGNS TYPICAL AT EACH APPROACH LEG STYLE.
2. ALL PROPOSED STRIPING AND SIGNING MUST BE APPROVED BY THE CITY TRAFFIC ENGINEER.
3. (NOT USED)
4. R3-8 ADVANCE INTERSECTION LANE CONTROL ARE NOT GENERALLY REQUIRED ON SINGLE LANE APPROACHES. ADDITIONAL R3-8 OR R3-8a ADVANCE INTERSECTION LANE CONTROL SIGNAGE MAY BE REQUIRED FOR MULTIPLE LANE APPROACHES.
5. CHECK MUTCD TABLE 2C-4 FOR SIGN PLACEMENT. MEASURE ALONG OUTSIDE CURB FACE FROM LEADING EDGE OF CROSSWALK.
6. ALL SIGN SHALL BE A MINIMUM CLEARANCE OF 18" FROM CLOSEST POINT OF SIGN FACE TO BACK OF CURB.
7. PVC SLEEVES TO BE CORED THROUGH PAVEMENT TO SOIL. CUT PVC OFF 1" ABOVE MEDIAN CAP. TELESPEAR SLEEVE BLANK TO EXTEND 36" MINIMUM BELOW SURFACE.

Computer File Information	
Creation Date:	5/27/11 Initials: SRA
Last Modification Date:	8/19/19 Initials: NAB
Full Path:	V:\Public Works\Civil Engineering\Design Tools\Roundabout Info\Design Manual\Exhibits
Drawing File Name:	Figure-8&9.dwg
Acad Ver.	C3D11 Scale: 1"=30' Units: ENGLISH

Sheet Revisions		
8/19/19	Updated for 2020 LCUASS	NAB

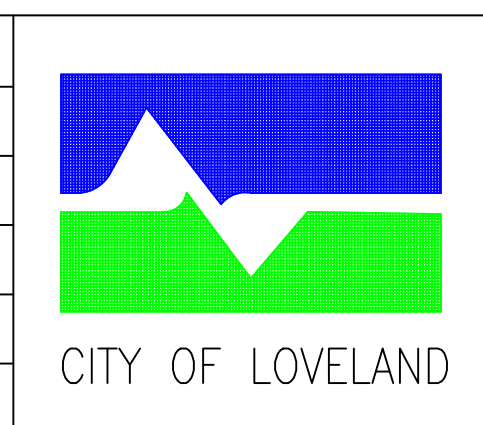

PUBLIC WORKS
TRAFFIC OPERATIONS
105 West Fifth Street
Loveland, Colorado 80537
Phone: (970) 962-2535
FAX: (970) 962-2908
www.cityofloveland.org/publicworks/traffic

As Constructed
No Revisions:
Revised:
Void:

FIGURE 9A STANDARD SIGNING			
Designer:	JTK	Structure Numbers:	
Detailer:	SRA	Subset Sheets:	
Sheet Subset:			

Project No./Code	
Sheet Number	1

SIGNING:
SINGLE-LANE ROUNDABOUT

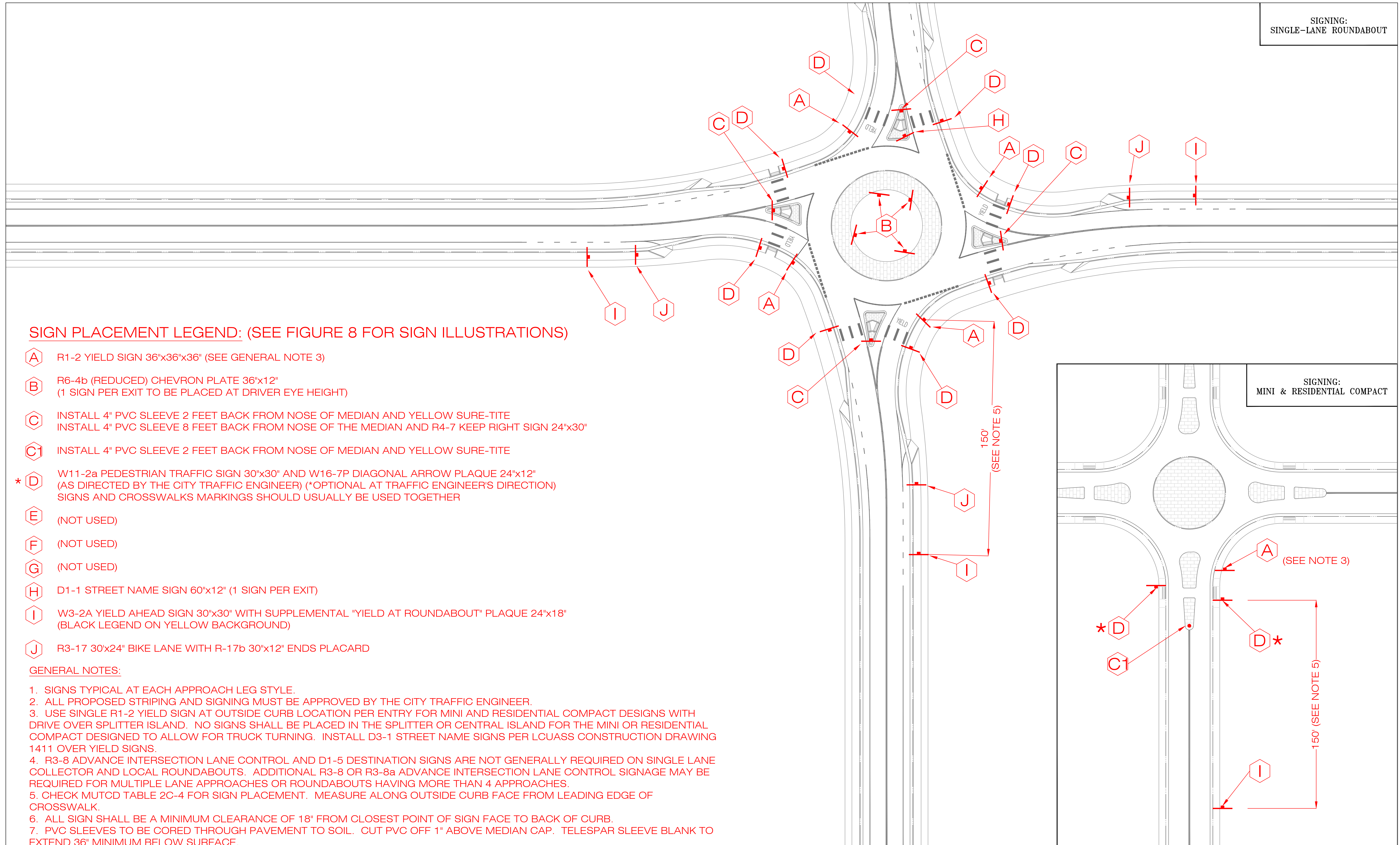

SIGN PLACEMENT LEGEND: (SEE FIGURE 8 FOR SIGN ILLUSTRATIONS)

- A** R1-2 YIELD SIGN 36"x36"x36" (SEE GENERAL NOTE 3)
- B** R6-4b (REDUCED) CHEVRON PLATE 36"x12"
(1 SIGN PER EXIT TO BE PLACED AT DRIVER EYE HEIGHT)
- C** INSTALL 4" PVC SLEEVE 2 FEET BACK FROM NOSE OF MEDIAN AND YELLOW SURE-TITE
INSTALL 4" PVC SLEEVE 8 FEET BACK FROM NOSE OF THE MEDIAN AND R4-7 KEEP RIGHT SIGN 24"x30"
- C1** INSTALL 4" PVC SLEEVE 2 FEET BACK FROM NOSE OF MEDIAN AND YELLOW SURE-TITE
- *D** W11-2a PEDESTRIAN TRAFFIC SIGN 30"x30" AND W16-7P DIAGONAL ARROW PLAQUE 24"x12"
(AS DIRECTED BY THE CITY TRAFFIC ENGINEER) (*OPTIONAL AT TRAFFIC ENGINEER'S DIRECTION)
SIGNS AND CROSSWALKS MARKINGS SHOULD USUALLY BE USED TOGETHER
- E** (NOT USED)
- F** (NOT USED)
- G** (NOT USED)
- H** D1-1 STREET NAME SIGN 60"x12" (1 SIGN PER EXIT)
- I** W3-2A YIELD AHEAD SIGN 30"x30" WITH SUPPLEMENTAL "YIELD AT ROUNDABOUT" PLAQUE 24"x18"
(BLACK LEGEND ON YELLOW BACKGROUND)
- J** R3-17 30"x24" BIKE LANE WITH R-17b 30"x12" ENDS PLACARD

GENERAL NOTES:

1. SIGNS TYPICAL AT EACH APPROACH LEG STYLE.
2. ALL PROPOSED STRIPING AND SIGNING MUST BE APPROVED BY THE CITY TRAFFIC ENGINEER.
3. USE SINGLE R1-2 YIELD SIGN AT OUTSIDE CURB LOCATION PER ENTRY FOR MINI AND RESIDENTIAL COMPACT DESIGNS WITH DRIVE OVER SPLITTER ISLAND. NO SIGNS SHALL BE PLACED IN THE SPLITTER OR CENTRAL ISLAND FOR THE MINI OR RESIDENTIAL COMPACT DESIGNED TO ALLOW FOR TRUCK TURNING. INSTALL D3-1 STREET NAME SIGNS PER LCUASS CONSTRUCTION DRAWING 1411 OVER YIELD SIGNS.
4. R3-8 ADVANCE INTERSECTION LANE CONTROL AND D1-5 DESTINATION SIGNS ARE NOT GENERALLY REQUIRED ON SINGLE LANE COLLECTOR AND LOCAL ROUNDABOUTS. ADDITIONAL R3-8 OR R3-8a ADVANCE INTERSECTION LANE CONTROL SIGNAGE MAY BE REQUIRED FOR MULTIPLE LANE APPROACHES OR ROUNDABOUTS HAVING MORE THAN 4 APPROACHES.
5. CHECK MUTCD TABLE 2C-4 FOR SIGN PLACEMENT. MEASURE ALONG OUTSIDE CURB FACE FROM LEADING EDGE OF CROSSWALK.
6. ALL SIGN SHALL BE A MINIMUM CLEARANCE OF 18" FROM CLOSEST POINT OF SIGN FACE TO BACK OF CURB.
7. PVC SLEEVES TO BE CORED THROUGH PAVEMENT TO SOIL. CUT PVC OFF 1" ABOVE MEDIAN CAP. TELESPEAR SLEEVE BLANK TO EXTEND 36" MINIMUM BELOW SURFACE.

SIGNING:
MINI & RESIDENTIAL COMPACT

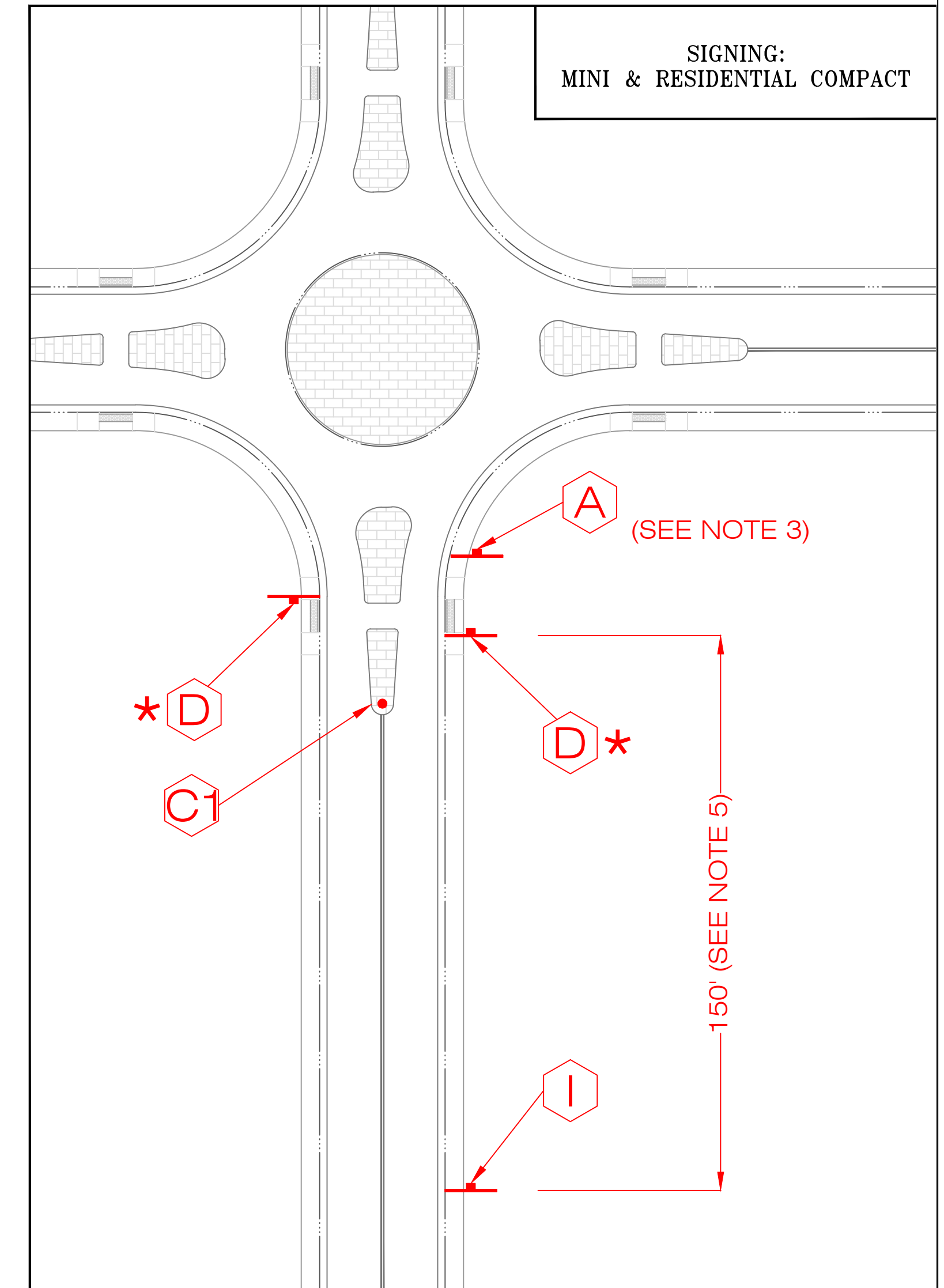

Computer File Information	
Creation Date:	5/27/11 Initials: SRA
Last Modification Date:	2/3/20 Initials: NAB
Full Path:	V:\Public Works\Civil Engineering\Design Tools\Roundabout Info\Design Manual\Exhibits
Drawing File Name:	Figure-8&9.dwg
Acad Ver.	C3D11 Scale: 1"=30' Units: ENGLISH

Sheet Revisions		
8/19/19	New for 2020 LCUASS	NAB

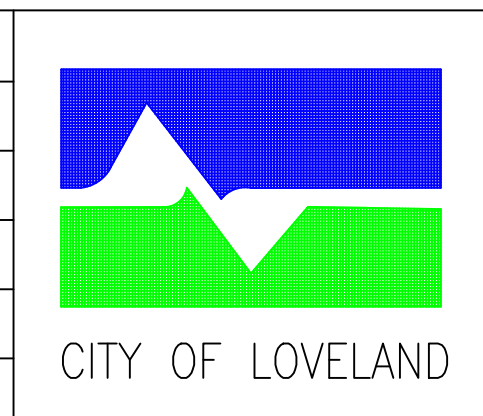

PUBLIC WORKS
TRAFFIC OPERATIONS
105 West Fifth Street
Loveland, Colorado 80537
Phone: (970) 962-2535
FAX: (970) 962-2908
www.cityofloveland.org/publicworks/traffic

As Constructed
No Revisions:
Revised:
Void:

**FIGURE 9B
STANDARD SIGNING**

Designer: JTK
Detailer: SRA
Structure Numbers:
Sheet Subset:
Subset Sheets:

Project No./Code
Sheet Number 1

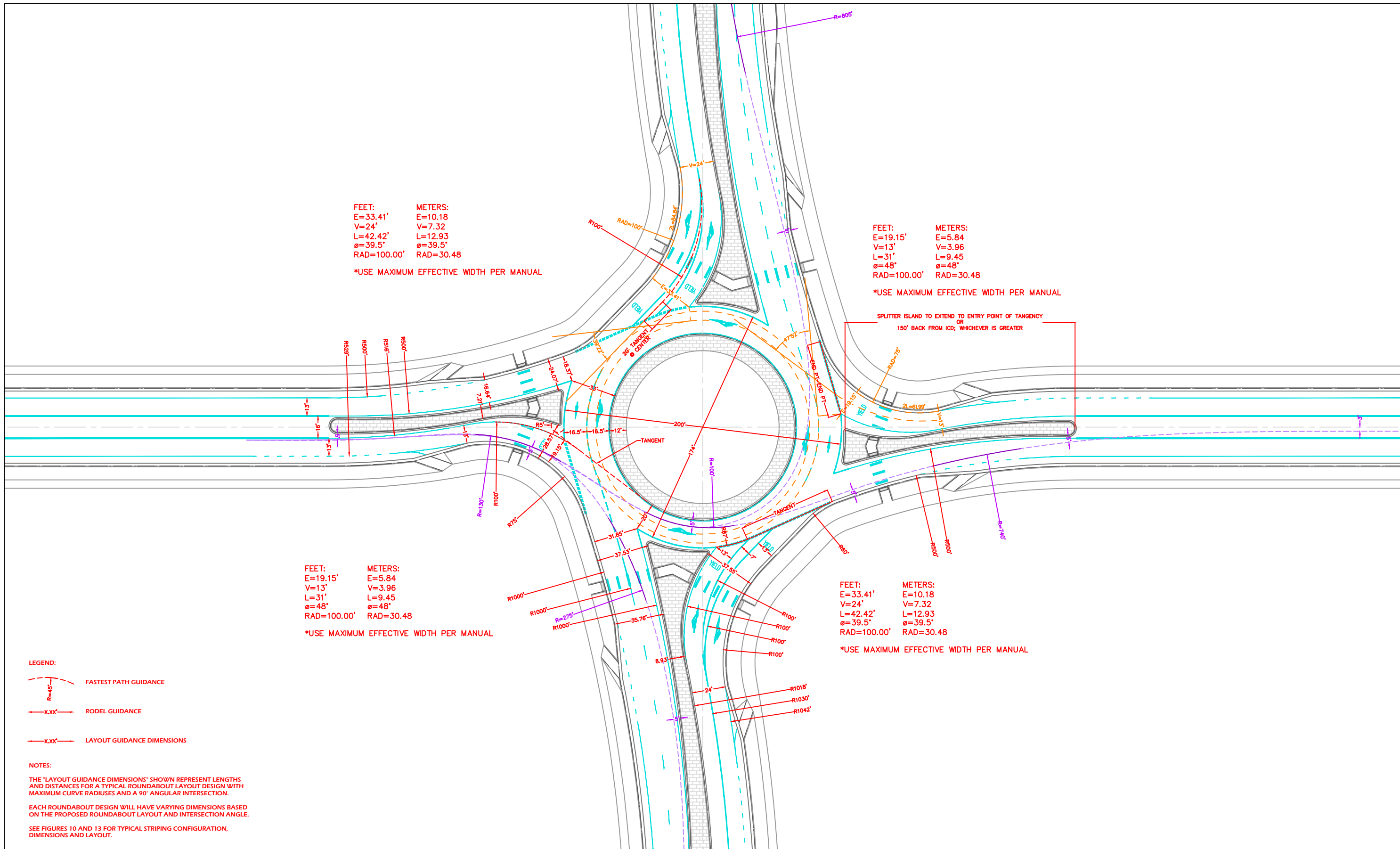

Computer File Information	
Creation Date:	5/27/11 Initials: SRA
Last Modification Date:	8/1/21 Initials: NAB
Full Path:	V:\Public Works\Civil Engineering\Design Tools\Roundabout Info\Design Manual\Exhibits
Drawing File Name:	2-lane-arterial_4-lane-arterial.dwg
Acad Ver.	C3D11
Scale:	1"=30' Units: ENGLISH

Sheet Revisions	

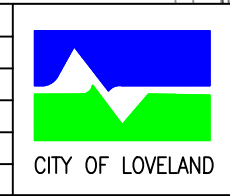

PUBLIC WORKS ENGINEERING
 410 East Fifth Street
 Loveland, Colorado 80537
 Phone: (970) 962-2627
 FAX: (970) 962-2908
 www.cityofloveland.org/publicworks

As Constructed
No Revisions:
Revised:
Void:

FIGURE 11	
2-Lane by 4-Lane Arterial	
Designer:	JTK
Detailer:	SRA
Sheet Subset:	

Project No./Code	
Sheet Number	1

- LEGEND:**
- FASTEST PATH GUIDANCE
 - RODEL GUIDANCE
 - STRIPING GUIDANCE
 - LAYOUT GUIDANCE DIMENSIONS

NOTES:

THE "LAYOUT GUIDANCE DIMENSIONS" SHOWN REPRESENT LENGTHS AND DISTANCES FOR A TYPICAL ROUNDABOUT LAYOUT DESIGN WITH MAXIMUM CURVE RADIIUSES AND A 90° ANGULAR INTERSECTION.

EACH ROUNDABOUT DESIGN WILL HAVE VARYING DIMENSIONS BASED ON THE PROPOSED ROUNDABOUT LAYOUT AND INTERSECTION ANGLE.

SEE FIGURES 10 AND 13 FOR TYPICAL STRIPING CONFIGURATION, DIMENSIONS AND LAYOUT.

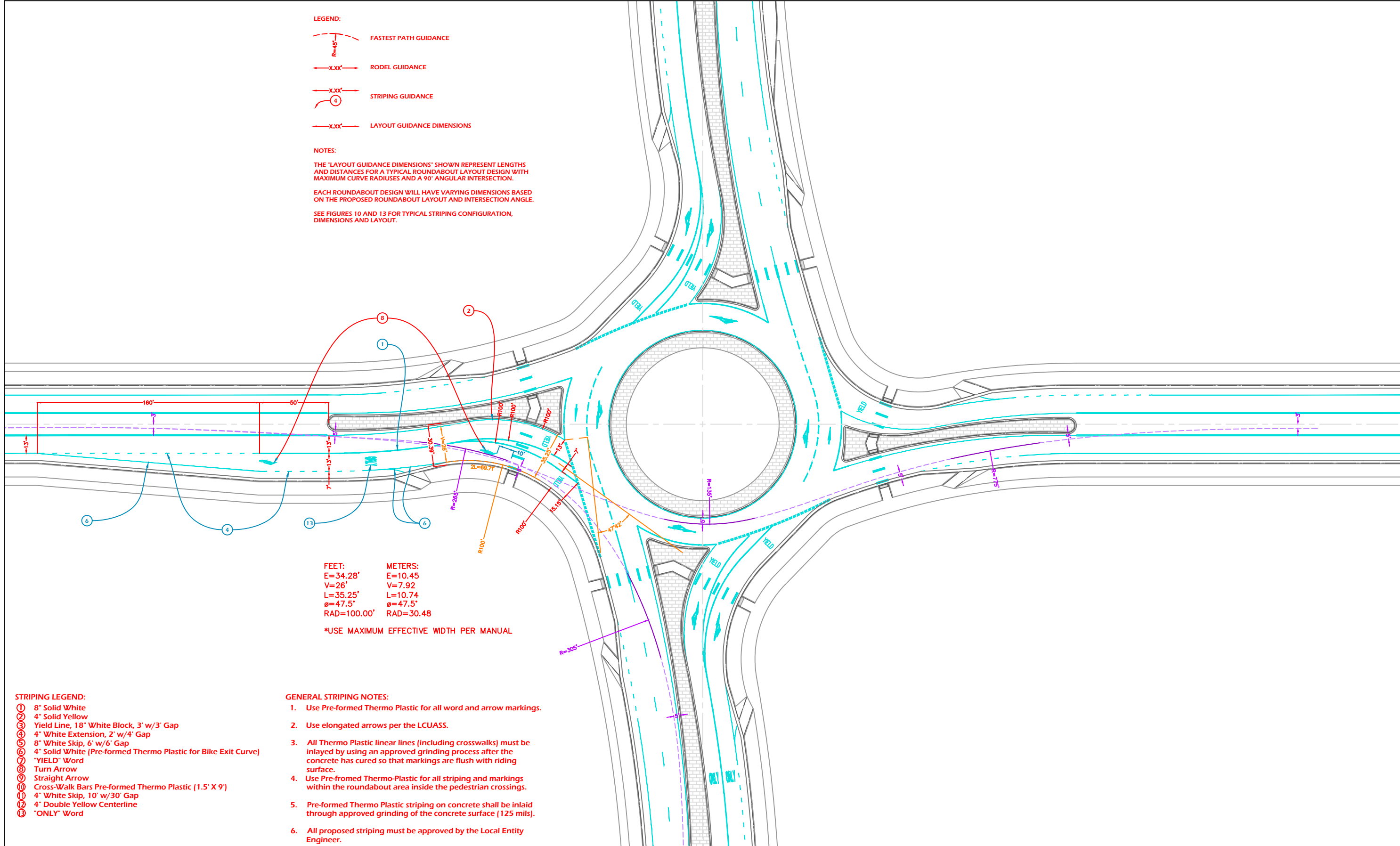

FEET: METERS:
 E=34.28' E=10.45
 V=26' V=7.92
 L=35.25' L=10.74
 ø=47.5' ø=47.5'
 RAD=100.00' RAD=30.48

*USE MAXIMUM EFFECTIVE WIDTH PER MANUAL

STRIPING LEGEND:

- ① 8" Solid White
- ② 4" Solid Yellow
- ③ Yield Line, 18" White Block, 3' w/3' Gap
- ④ 4" White Extension, 2' w/4' Gap
- ⑤ 8" White Skip, 6' w/6' Gap
- ⑥ 4" Solid White (Pre-formed Thermo Plastic for Bike Exit Curve)
- ⑦ "YIELD" Word
- ⑧ Turn Arrow
- ⑨ Straight Arrow
- ⑩ Cross-Walk Bars Pre-formed Thermo Plastic (1.5' X 9')
- ⑪ 4" White Skip, 10' w/30' Gap
- ⑫ 4" Double Yellow Centerline
- ⑬ "ONLY" Word

GENERAL STRIPING NOTES:

1. Use Pre-formed Thermo Plastic for all word and arrow markings.
2. Use elongated arrows per the LCUASS.
3. All Thermo Plastic linear lines (including crosswalks) must be inlaid by using an approved grinding process after the concrete has cured so that markings are flush with riding surface.
4. Use Pre-formed Thermo-Plastic for all striping and markings within the roundabout area inside the pedestrian crossings.
5. Pre-formed Thermo Plastic striping on concrete shall be inlaid through approved grinding of the concrete surface (125 mils).
6. All proposed striping must be approved by the Local Entity Engineer.

Computer File Information	
Creation Date:	5/27/11 Initials: SRA
Last Modification Date:	8/1/21 Initials: NAB
Full Path:	V:\Public Works\Civil Engineering\Design Tools\Roundabout Info\Design Manual\Exhibits
Drawing File Name:	2-lane-arterial_4-lane-arterial.dwg
Acad Ver.	C3D11 Scale: 1"=30' Units: ENGLISH

Sheet Revisions	

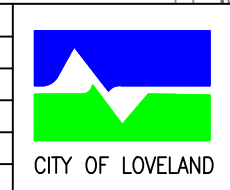

PUBLIC WORKS ENGINEERING
 410 East Fifth Street
 Loveland, Colorado 80537
 Phone: (970) 962-2627
 FAX: (970) 962-2908
 www.cityofloveland.org/publicworks

As Constructed
No Revisions:
Revised:
Void:

FIGURE 12 2-Lane by 4-Lane Arterial with By-pass Lane	
Designer:	JTK
Detailer:	SRA
Sheet Subset:	
Subset Sheets:	

Project No./Code
Sheet Number

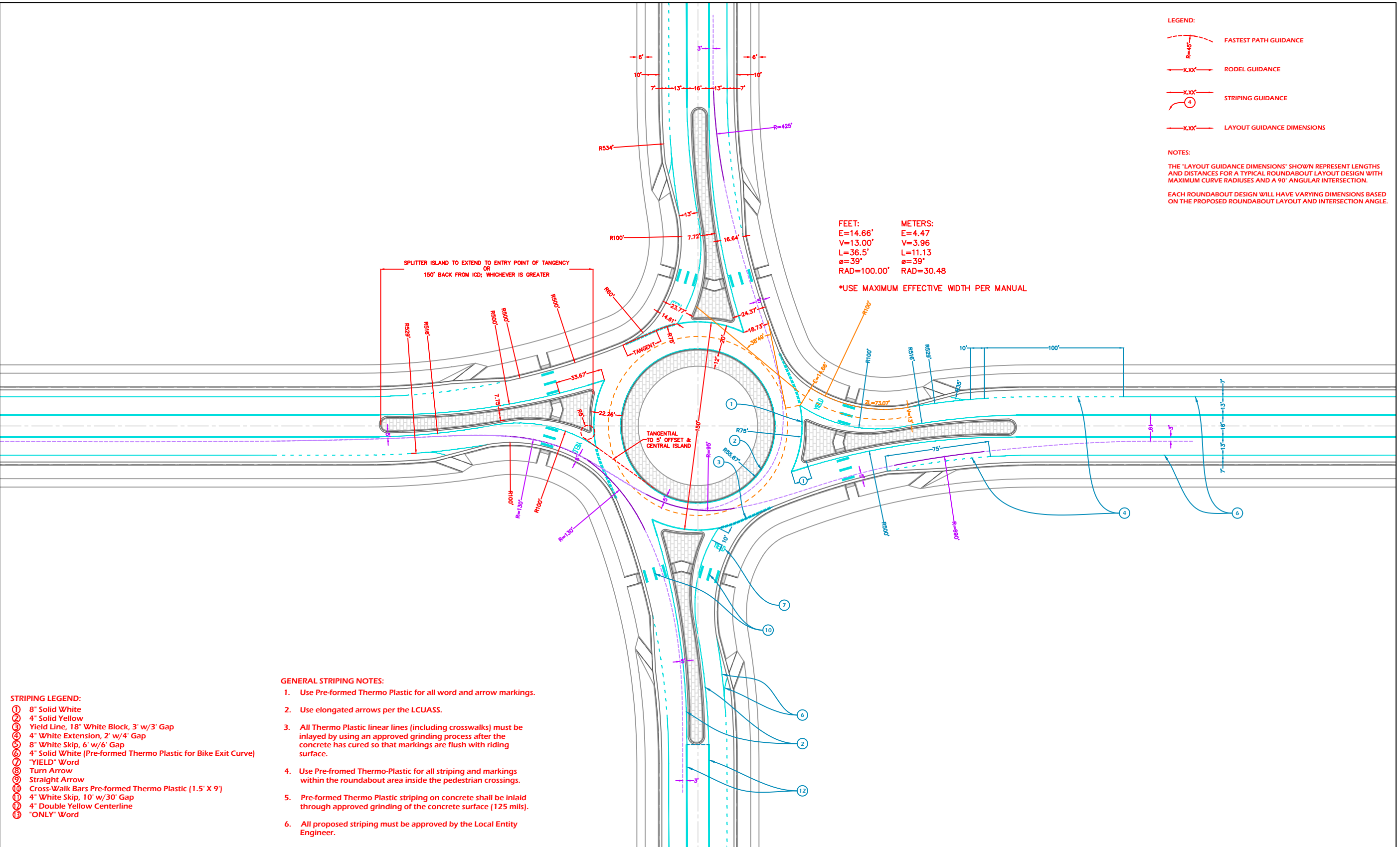

Computer File Information	
Creation Date:	5/27/11 Initials: SRA
Last Modification Date:	8/1/21 Initials: NAB
Full Path:	V:\Public Works\Civil Engineering\Design Tools\Roundabout Info\Design Manual\Exhibits
Drawing File Name:	4-lane-arterial_4-lane-arterial.dwg
Acad Ver.	C3D11 Scale: 1"=30' Units: ENGLISH

Sheet Revisions			
(R-1)	8/1/21	2021 LCUASS	NAB

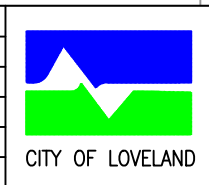



PUBLIC WORKS ENGINEERING
 410 East Fifth Street
 Loveland, Colorado 80537
 Phone: (970) 962-2627
 FAX: (970) 962-2908
www.cityofloveland.org/publicworks

As Constructed
No Revisions:
Revised:
Void:

FIGURE 13	
2-Lane by 2-Lane Arterial	
Designer:	JTK
Detailer:	SRA
Sheet Subset:	
Subset Sheets:	

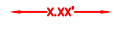
Project No./Code	
Sheet Number	1

- LEGEND:**
-  FASTEST PATH GUIDANCE
 -  RODEL GUIDANCE
 -  STRIPING GUIDANCE
 -  LAYOUT GUIDANCE DIMENSIONS

NOTES:

THE "LAYOUT GUIDANCE DIMENSIONS" SHOWN REPRESENT LENGTHS AND DISTANCES FOR A TYPICAL ROUNDABOUT LAYOUT DESIGN WITH MAXIMUM CURVE RADII AND A 90° ANGULAR INTERSECTION.

EACH ROUNDABOUT DESIGN WILL HAVE VARYING DIMENSIONS BASED ON THE PROPOSED ROUNDABOUT LAYOUT AND INTERSECTION ANGLE.

FEET: METERS:
 E=14.61' E=4.45
 V=12' V=3.66
 L=35.85' L=10.93
 θ=39° θ=39°
 RAD=100.00' RAD=30.48

*USE MAXIMUM EFFECTIVE WIDTH PER MANUAL

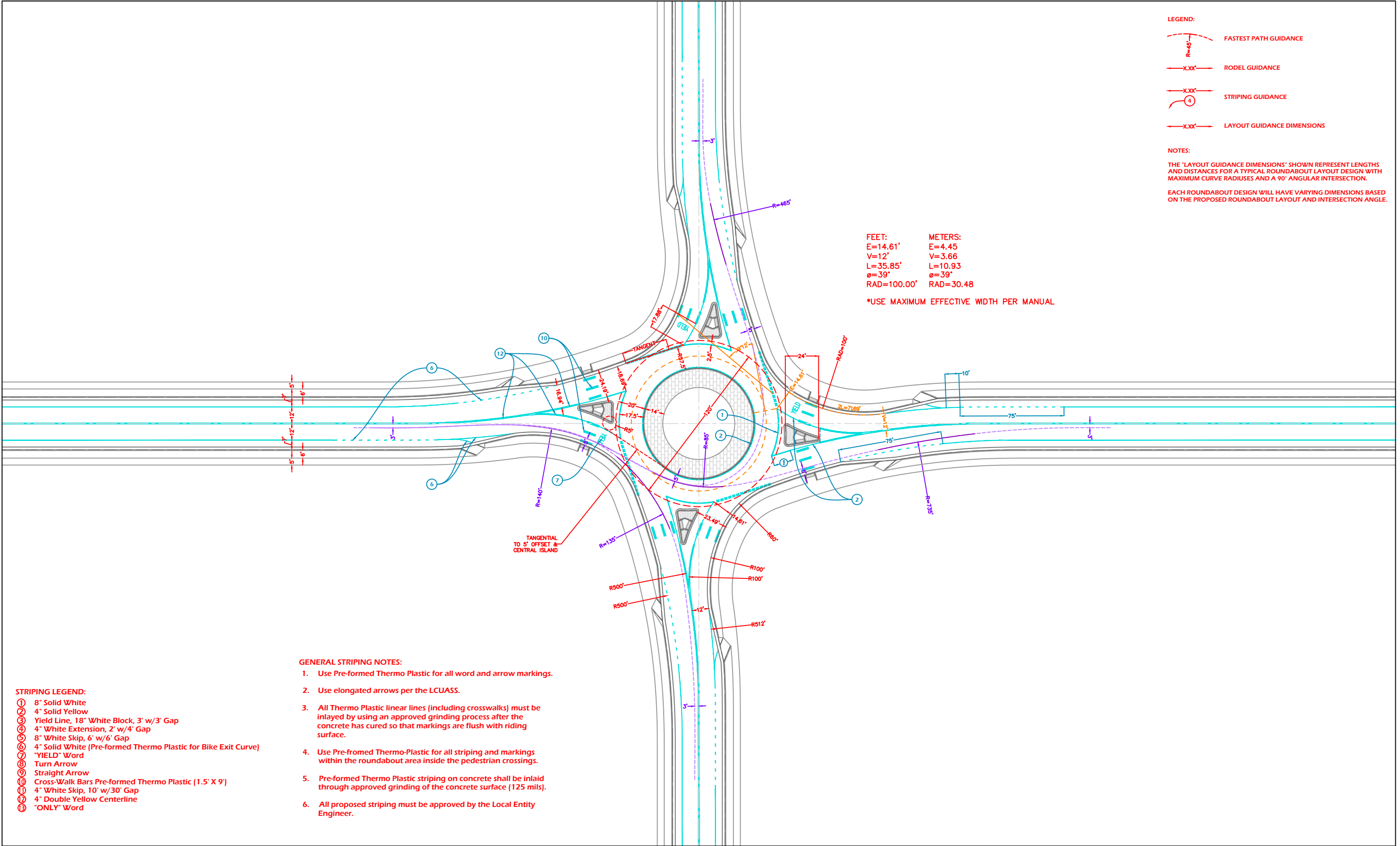

- GENERAL STRIPING NOTES:**
1. Use Pre-formed Thermo Plastic for all word and arrow markings.
 2. Use elongated arrows per the LCUASS.
 3. All Thermo Plastic linear lines (including crosswalks) must be inlaid by using an approved grinding process after the concrete has cured so that markings are flush with riding surface.
 4. Use Pre-formed Thermo-Plastic for all striping and markings within the roundabout area inside the pedestrian crossings.
 5. Pre-formed Thermo Plastic striping on concrete shall be inlaid through approved grinding of the concrete surface (125 mils).
 6. All proposed striping must be approved by the Local Entity Engineer.

- STRIPING LEGEND:**
- ① 8" Solid White
 - ② 4" Solid Yellow
 - ③ Yield Line, 18" White Block, 3' w/3' Gap
 - ④ 4" White Extension, 2' w/4' Gap
 - ⑤ 8" White Skip, 6' w/6' Gap
 - ⑥ 4" Solid White (Pre-formed Thermo Plastic for Bike Exit Curve)
 - ⑦ "YIELD" Word
 - ⑧ Turn Arrow
 - ⑨ Straight Arrow
 - ⑩ Cross-Walk Bars Pre-formed Thermo Plastic (1.5' X 9')
 - ⑪ 4" White Skip, 10' w/30' Gap
 - ⑫ 4" Double Yellow Centerline
 - ⑬ "ONLY" Word

Computer File Information	
Creation Date:	5/27/11 Initials: SRA
Last Modification Date:	8/1/21 Initials: NAB
Full Path:	V:\Public Works\Civil Engineering\Design Tools\Roundabout Info\Design Manual\Exhibits
Drawing File Name:	4-lane-arterial_4-lane-arterial.dwg
Acad Ver. C3D11	Scale: 1"=30' Units: ENGLISH

Sheet Revisions		
(R-1)	8/1/21	2021 LCUASS NAB



PUBLIC WORKS ENGINEERING
 410 East Fifth Street
 Loveland, Colorado 80537
 Phone: (970) 962-2627
 FAX: (970) 962-2908
 www.cityofloveland.org/publicworks

As Constructed
No Revisions:
Revised:
Void:

FIGURE 14 Collector	
Designer:	JTK Structure Numbers
Detailer:	SRA
Sheet Subset:	Subset Sheets:

Project No./Code
Sheet Number

