

LARIMER COUNTY

STORMWATER DESIGN STANDARDS



2023

TABLE OF CONTENTS

CHAPTER 1.0	General Provisions.....	9
1.1	Introduction	9
1.2	Purpose	9
1.3	Jurisdiction	9
1.4	Administration	9
1.5	Review and Approval	9
1.6	Interpretation.....	10
1.7	Variances.....	10
1.8	Amendments to the Standards.....	11
CHAPTER 2.0	Drainage Report Submittal Requirements	12
2.1	Introduction	12
2.2	Drainage Letter	12
2.2.1	Drainage Narrative	12
2.2.2	Drainage Features.....	13
2.2.3	Drainage Plan.....	13
2.3	Preliminary Drainage Report.....	13
2.3.1	General Report Requirements.....	13
2.3.2	Drainage Narrative	13
2.3.2.1	Introduction	13
2.3.2.2	General Location and Description	14
2.3.2.3	Drainage Basins and Sub-Basins	14
2.3.2.4	Drainage Design Criteria.....	14
2.3.2.5	Drainage Facility Design.....	15
2.3.2.6	Conclusions.....	15
2.3.2.7	References	15
2.3.2.8	Appendices	15
2.3.3	Drainage Plan.....	16
2.3.3.1	Overall Drainage Map.....	16
2.3.3.2	Detailed Drainage Plan	16
2.4	Final Drainage Report	16
2.4.1	Drainage Narrative	16
2.4.1.1	Drainage Design Criteria.....	16
2.4.1.2	Drainage Facility Design.....	17
2.4.1.3	Appendices	17
2.4.2	Drainage Plan.....	17
2.4.3	Erosion Control Plan	17
2.4.4	Construction Plans.....	17
2.5	As-Builts and Site Certification.....	18
2.5.1	Lot-Grading Certification	18
2.6	Variances.....	18
2.7	Certification.....	18

CHAPTER 3.0	Drainage Principles and Policies.....	19
3.1	Introduction	19
3.2	Principles.....	19
3.3	Planning Policies	21
3.4	Technical/Design Standards Policies.....	23
3.5	Operation and Maintenance Policies.....	24
3.6	Floodplain Management Policies.....	25
CHAPTER 4.0	Floodplains	26
4.1	Introduction	26
4.2	Floodplain Regulations.....	26
4.3	Definitions.....	26
4.4	Floodplain Overlay District.....	27
4.5	Floodplain Development Permits	28
4.5.1	Exclusions	28
4.5.2	Standards.....	28
4.5.3	Permit Process	28
4.5.4	Submittals.....	28
4.5.5	Flood Review Board.....	29
4.6	Additional Resources	30
CHAPTER 5.0	Rainfall.....	31
5.1	Introduction	31
5.2	Retrieving Data from NOAA Atlas 14	31
5.3	Intensity-Duration-Frequency.....	31
5.4	Design Storm Distributions	32
5.5	Example.....	33
5.6	Submittal Requirements	35
5.7	References	35
CHAPTER 6.0	Runoff.....	36
6.1	Introduction	36
6.2	Rational Method	37
6.3	Colorado Urban Hydrograph Procedure (CUHP)	38
6.4	EPA Stormwater Management Model (SWMM)	38
6.5	Hydrologic Engineering Center – Hydrologic Modeling System (HEC-HMS)	38
6.6	Streamflow Statistical Analysis	39
6.7	StreamStats.....	39
6.8	Offsite Flows (Upstream).....	39
6.9	Post-Fire Runoff Considerations	40
6.10	Submittal Requirements	40
6.11	References	40
CHAPTER 7.0	Streets.....	41
7.1	Introduction	41
7.2	Street Classifications	41

7.3	Minor and Major Events	41
7.4	Encroachment and Cross-Street Flow Criteria.....	42
7.5	Design Procedures	43
7.6	Submittal Requirements	43
CHAPTER 8.0 Inlets		44
8.1	Introduction	44
8.2	Inlet Types and Application.....	44
8.3	Design Procedures and Considerations	45
8.4	Submittal Requirements	45
CHAPTER 9.0 Storm Drains		46
9.1	Introduction	46
9.2	Pipe Sizes and Materials	46
9.3	Manholes	46
9.4	Storm Drain Outlets	46
9.5	Storm Drain Cover.....	47
9.6	Hydraulic Design	47
9.7	Design Procedures	47
9.8	Submittal Requirements	48
CHAPTER 10.0 Culverts.....		49
10.1	Introduction	49
10.2	Design Criteria and Considerations.....	49
10.2.1	Additional Requirements, References and Guidelines.....	49
10.2.2	Culvert Classification, Design Event, Headwater Depths	49
10.2.3	Culvert Size and Material.....	51
10.2.4	Inlet and Outlet Design.....	52
10.2.5	Cover Depth.....	53
10.2.6	Velocity and Outlet Protection	53
10.2.7	Debris Control (Post-Fire Areas).....	53
10.3	Design Procedures	53
10.4	Submittal Requirements	53
10.5	Permits	54
10.6	References	54
CHAPTER 11.0 Bridges		55
11.1	Introduction	55
11.2	Design Criteria and Considerations.....	55
11.2.1	Design Events.....	55
11.2.2	Freeboard	56
11.2.3	Debris Control (Post-Fire Areas).....	56
11.3	Design Procedures	56
11.3.1	Hydraulic Analysis.....	56
11.3.2	Scour Analysis	56
11.4	Submittal Requirements	57

11.5	Permits	57
11.6	References	58
CHAPTER 12.0 Open Channels		59
12.1	Introduction	59
12.2	Design Criteria and Considerations – Swales	59
12.2.1	Type	59
12.2.2	Design Event and Freeboard	59
12.2.3	Cross-Section	59
12.2.4	Hydraulic Design Requirements	59
12.2.4.1	Grass Swales	59
12.2.4.2	Riprap-Lined Swales.....	60
12.2.5	Common Area Lots, Outlots and Easements.....	61
12.3	Roadside Ditches.....	61
12.4	Naturalized Channels	61
12.5	Hydraulic Analysis	61
12.5.1	Manning’s Equation.....	61
12.5.2	Hydraulic Modeling.....	62
12.5.3	Roughness Coefficients.....	62
12.6	Submittal Requirements	63
CHAPTER 13.0 Hydraulic Structures		68
13.1	Introduction	68
13.2	Supplemental Guidance	68
13.2.1	Grade Control Structures.....	68
13.2.2	Outfalls and Rundowns.....	68
13.2.3	Rundowns	69
13.3	Submittal Requirements	69
CHAPTER 14.0 Detention (Storage).....		70
14.1	Introduction	70
14.2	Threshold for Requiring Detention	70
14.3	Detention Volume Requirements and Allowable Release Rates	71
14.4	Types of Detention Facilities	71
14.5	Detention and Water Rights	72
14.6	Design Criteria and Considerations.....	73
14.7	Impacts to Downstream Property and Infrastructure	73
14.8	Maintenance	74
14.9	Submittal Requirements	74
14.10	References	74
CHAPTER 15.0 Post-Construction Stormwater Controls		75
15.1	Introduction	75
15.1.1	Four Step Process for Stormwater Quality Management	75
15.2	Runoff Reduction Practices (LID/MCDIA)	76
15.2.1	Runoff Reduction Practices and Design Criteria.....	76

15.2.2	Submittal Requirements.....	77
15.3	Water Quality SCMs.....	77
15.3.1	SCM Selection and Application.....	78
15.3.2	Water Quality SCM Design Criteria	80
15.3.3	Maintenance.....	81
15.3.4	Submittal Requirements.....	81
CHAPTER 16.0	Construction Stormwater Management.....	82
16.1	Introduction	82
16.2	Development Construction Permit.....	82
16.3	Land Disturbance Permit.....	82
16.4	Erosion and Sediment Control Plan	83
16.4.1	General Information and Site Description.....	83
16.4.2	Construction Stormwater Control Measures	83
16.4.3	Inspections and Maintenance	84
16.4.4	Final Stabilization and Long-term Stormwater Management	84
16.4.5	Plan Map/Drawings	84
16.4.6	Erosion Control Escrow.....	84
16.5	Enforcement	85
16.6	REFERENCES.....	85
CHAPTER 17.0	Revegetation	86
17.1	Introduction	86
17.2	Site Preparation	86
17.3	Plant Material Selection.....	87
17.4	Plant Installation	88
17.5	Mulching	88
17.6	Maintenance	89
17.7	Post-construction Monitoring.....	89
17.8	Post-Fire Revegetation.....	90
17.9	Submittal Requirements	90
17.10	Permits	90
17.11	References and Resources.....	90

TABLES

Table 5-1.	from MHFD Manual showing 2-hour design storm distributions based on 1-hour precipitation depths.....	32
Table 6-1.	Accepted Hydrologic Runoff Methods in Larimer County.....	36
Table 6-2:	Percent imperviousness values to be used in hydrologic modeling	37
Table 7-1	Minor and major storm design events for rural and urban streets and roadways.....	41
Table 7-2	Encroachment criteria for minor storm event.....	42
Table 7-3	Encroachment criteria for major storm event.....	42
Table 7-4	Allowable cross-street flow depths using cross-pans.....	43
Table 8-1	Inlet type and application	44

Table 9-1. Allowable values for storm drain design parameters.....	47
Table 10-1. Design Event, Maximum Headwater Depth and Overtopping Depth Criteria*	51
Table 10-2. Culvert Size and Material Requirements	52
Table 11-1. Hydraulic Design, Scour Design, and Scour Design Check Flood Frequencies (modified from HEC-18)	57
Table 12-1. Hydraulic design criteria for vegetated (grass) swales	60
Table 12-2: Typical roughness coefficients (based on Table 8-5 in MHFD Manual)	63
Table 13-1. Erosion control and energy dissipation structure types.....	69
Table 14-1: Types of Detention Facilities and Allowable Applications.....	72
Table 14-2: Types of facilities requiring notification per CRS §37-92-602(8) (From MHFD Memorandum regarding CRS §37-92-602(8)).....	73
Table 15-1. Water Quality SCM Selection and Application	79
Table 15-2. Drain Time Coefficients for WQCV Calculations (Taken from MHFD Manual Volume 3)	81
Table 17-1: Site preparation activities for revegetating upland, riparian and wetland habitats, with chapter references from the Revegetation chapter of the MHFD Manual	87
Table 17-2: Plant material for revegetating upland, riparian and wetland habitat types, with chapter references from the Revegetation chapter of the MHFD Manual	87
Table 17-3: Installation methods for revegetating upland, riparian and wetland habitat types, with chapter references from the Revegetation chapter of the MHFD Manual	88

FIGURES

Figure 4-1. Floodplain Development Permit Flowchart (From Larimer County Floodplain Development Guide)	29
Figure 5-1. Location near Red Feather Lakes selected for point precipitation estimates using NOAA Atlas 14	33
Figure 5-2. Output table of precipitation intensity estimates including 90% confidence intervals produced for a point near Red Feather Lakes using NOAA Atlas 14	34
Figure 5-3. Intensity-duration-frequency curve generated from NOAA Atlas 14 data for a point outside Red Feather Lakes	35
Figure 8-1: Perspective view of different inlet types.....	45
Figure 10-1. Culvert Classification Diagram.....	50
Figure 10-2. Example End Section for Reinforced Concrete Circular Pipe from CDOT Standard Plan No. M-603-10	52
Figure 12-1. Swale stability chart: 2- to 4-foot bottom width and side slopes between 5:1 and 10:1 (Note: Riprap classifications refer to gradation for riprap used in soil riprap or void-filled riprap.) (Source: Muller Engineering Company from MHFD, USDCM Volume 1, Chapter 8).....	64

Figure 12-2. Swale stability chart: 2- to 4-foot bottom width and 10:1 (or flatter) side slopes (Note: Riprap classifications refer to gradation for riprap used in soil riprap or void-filled riprap.) (Source: Muller Engineering Company from MHFD, USDCM Volume 1, Chapter 8)..... 65

Figure 12-3. Swale stability chart: greater than 4-foot bottom width and side slopes between 5:1 and 10:1 (Note: Riprap classifications refer to gradation for riprap used in soil riprap or void-filled riprap.) (Source: Muller Engineering Company from MHFD, USDCM Volume 1, Chapter 8)..... 66

Figure 12-4. Swale stability chart: greater than 4-foot bottom width and 10:1 (or flatter) side slopes (Note: Riprap classifications refer to gradation for riprap used in soil riprap or void-filled riprap.) (Source: Muller Engineering Company from MHFD, USDCM Volume 1, Chapter 8)..... 67

APPENDICES

Appendix A: Submittals Checklists

Appendix B: Construction Stormwater Management – Guidance Document

Appendix C: Construction Stormwater Management – ESCP Checklist

Appendix D: Construction Stormwater Management – Standard Forms

Appendix E: Construction Stormwater Management – Construction Plan Symbols

Appendix F: Construction Stormwater Management – Standard Notes

Appendix G: Construction Stormwater Management – Erosion Control Fact Sheets

Appendix H: Construction Stormwater Management – Sediment Control Fact Sheets

Appendix I: Construction Stormwater Management – Materials Management Fact Sheets

Appendix J: Construction Stormwater Management – Site Management Fact Sheets

Appendix K: Seed Mixes for Revegetation

CHAPTER 1.0 GENERAL PROVISIONS

1.1 Introduction

These Stormwater Design Standards (Standards) have been developed by the Larimer County Engineering Department and adopted by resolution by the Larimer County Board of County Commissioners.

1.2 Purpose

The purpose of these Standards is to establish minimum storm drainage criteria for the public safety, health, comfort, convenience, welfare and economic well-being of residents and owners of property within the County. These Standards present policies and minimum technical criteria for the planning, analysis, design and maintenance of storm drainage systems in the County. Any policies or technical criteria that are not specifically addressed in these Standards shall follow those of the most recent version of the Mile High Flood District's Urban Storm Drainage Criteria Manual (MHFD Manual), which is incorporated in these Standards by reference.

1.3 Jurisdiction

These Standards shall apply in all lands within unincorporated Larimer County including, but not limited to, to the following:

- All storm drainage systems and facilities within Larimer County rights-of-way, drainage easements (public and private) or other public-use easements.
- All privately-owned and maintained storm drainage systems and facilities.
- All new development, minor expansion, change of use, or major redevelopment, as defined in the Larimer County Land Use Code.
- The administration of drainage, floodplain and water quality provisions of the Larimer County Land Use Code and all other ordinances and regulations that require a review of drainage conditions on any property within the County.

1.4 Administration

The County Engineer is responsible for administration and enforcement of these Standards, including review of all drainage studies, plans and specifications for drainage improvements; interpretation and enforcement of the provisions of these Standards; and application of sound engineering judgement in implementing the requirements found in these Standards.

1.5 Review and Approval

The County will review all submittals for general conformance with these Standards. However, an approval by the County does not relieve the owner, engineer, or designer from responsibility

for ensuring that the calculations, plans, specifications, construction and record drawings are in compliance with these Standards, as stated in the certification of the owner's engineer.

The County may also refer submittals to other local, state or federal agencies that have an interest or responsibility for drainage and/or water quality issues.

1.6 Interpretation

The County Engineer will interpret and apply the provisions of these Standards using the following governing statements:

- These Standards provide the minimum requirements to protect the public health, safety, comfort, convenience, prosperity, and welfare of the residents of Larimer County, protect property, and minimize adverse impacts to the environment.
- Whenever a provision of these Standards and any other provisions of the Larimer County Land Use Code, law, ordinance, resolution, rule or regulation of any kind, contains any requirement(s) covering any of the same subject matter, the requirements that are more restrictive or impose higher standards will govern.
- These Standards do not abrogate or annul any easements, permits, drainage reports or construction drawings accepted by the County prior to the effective date of these Standards.
- The County Engineer has final authority to resolve any conflicting interpretations of these Standards.

1.7 Variances

Variances from the provisions of these Standards are strongly discouraged but will be considered on a case-by-case basis. A formal variance request must be submitted to the County Engineer with the following information, at a minimum, included:

- Identify the specific standard (name, number, and/or applicable language) that the variance request pertains to.
- Description and discussion of the conditions and constraints that justify the variance request.
- Description, discussion, and analysis of the proposed alternative(s).
- The Variance Request Application Fee (if applicable) must be paid.
- All variance request submittals must be signed and stamped by a professional engineer licensed in Colorado.

The County Engineer may approve a variance request if the applicant can clearly and reasonably demonstrate the following:

- The applicant has established that the standard(s) cannot be achieved due to circumstances outside of their control.

- The variance will address a unique condition that is unusual for a project of similar type, extent, magnitude or location.
- The variance represents the least deviation from the standard that will provide relief and still meet the intent of the standard.
- The variance does not increase costs of public storm drainage facilities or other public facilities, including capital costs, maintenance costs, and lifecycle costs.
- The variance does not cause undue negative impact to public safety, health, welfare and environment.

The County Engineer will notify the applicant in writing of approval or denial of the variance request.

1.8 Amendments to the Standards

These Standards may be amended over time to address new regulations, updated data and information, and overall lessons learned from the past. Such amendments shall include, by reference, updates to the MHFD Manual. Minor amendments may only require approval of the County Engineer, while all major amendments will require approval of the Board of County Commissioners. Minor amendments are those that do not substantially change a policy or technical criteria such as changes to submittal requirements, clarifications, guidance and grammar.

CHAPTER 2.0 DRAINAGE REPORT SUBMITTAL REQUIREMENTS

2.1 Introduction

This chapter outlines the requirements and procedures for submittal of drainage plans and reports in the County. A general description of items to be included in the drainage report follows. Please refer to the detailed Submittal checklists in the Appendices of the Standards and on the County's website for a comprehensive list of required items. The requirements for submittal shall include a Preliminary Drainage Report, a Final Drainage Report and construction plans for drainage improvements. Under certain circumstances, an abbreviated Drainage Letter may be allowed, with approval from the County Engineer. All storm drainage plans shall be checked for conformance to the design criteria set forth in the Standards. Written approval of drainage plans must be obtained before any construction begins.

2.2 Drainage Letter

A Drainage Letter may be considered for sites that fall within a project boundary with a previously approved drainage report or for minor changes to existing properties. The Letter usually consists of an abbreviated narrative and simplified drainage plan, which the County may require to be signed and sealed by a qualified professional engineer licensed in the State of Colorado. All the following criteria must be met to substitute a Drainage Letter for a full drainage report:

- Prior approval must be obtained from the County Engineer.
- Any off-site drainage through the property must be adequately conveyed.
- The project does not alter the existing drainage pattern.
- The adjacent and downstream surface drainage system will hydraulically accommodate post-development runoff.
- No additional drainage infrastructure is required or proof of no injury to downstream properties is provided.

The following sections describe some of the submittal requirements for a drainage letter.

2.2.1 Drainage Narrative

The Letter must identify the project location, the project land use, any minor drainage changes to previously approved drainage studies and describe how it will be in general conformance with any previously approved drainage studies, if applicable.

For those sites without a previously approved drainage study, include a discussion of on- and off-site drainage patterns, list any drainage features on-site or nearby, and describe any drainage easements on the property.

Describe the approximate area of land disturbance and discuss sediment and erosion control during and after construction.

2.2.2 Drainage Features

Identify drainage features that are on-site and/or adjacent to the site such as culverts, drainages, lakes or reservoirs, rivers, irrigation ditches, low ponding areas and wetlands. Provide photos of any existing drainage features.

2.2.3 Drainage Plan

Provide a map of the site that includes property and project boundaries, contours, existing and proposed drainage patterns and facilities, and other relevant site characteristics.

2.3 Preliminary Drainage Report

A Preliminary Drainage Report (PDR) shall be submitted prior to a Final Drainage Report. The overall intent of the PDR and the County's review of the PDR is to demonstrate the proposed project is technically feasible (from a stormwater management perspective) and to identify potential drainage issues that should be addressed prior to moving to final design. The PDR shall include a complete evaluation of current drainage conditions and a preliminary, conceptual plan for handling drainage prior to actual sizing of facilities.

The following sections describe some of the submittal requirements for a PDR.

2.3.1 General Report Requirements

The report shall be typed on 8-1/2" x 11" paper and submitted electronically in pdf format or equivalent. A professional engineer's certification statement is required with stamps and signatures on reports and plans. The PDR Checklist shall be filled out by the design engineer and submitted along with the report.

2.3.2 Drainage Narrative

The drainage report must include a narrative description of the project location and any existing and proposed characteristics that influence drainage on the site. A preliminary design of the drainage facility and criteria used shall be included, as well as a discussion of how the proposed design will comply with all standards and adequately control runoff from the site.

2.3.2.1 Introduction

The introduction section of the narrative shall include a general project description and include proposed land use(s).

2.3.2.2 General Location and Description

A description of the project location should include general spatial information, such as adjacent streets; township, range, and section; and the names of any surrounding developments. A location map should accompany this section.

The property description shall include all characteristics relevant to stormwater drainage, including ground cover and soils, groundwater, any existing stormwater and irrigation facilities and easements, as well as any history of flooding on the site or the adjacent properties.

2.3.2.3 Drainage Basins and Sub-Basins

The report narrative shall include a description of the major drainage basin in which the project site is located. Any previous basin studies should be referenced and the applicable FEMA Flood Insurance Rate Map. Include a discussion of any discharge or detention requirements identified in previous basin studies and relevant to the project. Nearby irrigation facilities, reservoirs, or emergency spillways that may affect drainage or be affected by drainage from the site should be included, as well as an identification of all outfalls to the major drainageways. A statement must be made as to the effect of the development on hazard ratings of any reservoirs in the area.

The report narrative should also include a description of the sub-basin(s) delineated for the project site. The narrative should include the sub-basin name, proposed imperviousness, major and minor peak discharge rates, and discharge location or design point. Assumptions for upstream development must take into account planned development upstream and be based on information and discussions with adjacent property owners and the Larimer County Planning Department. These assumptions should be clearly stated and justifications for the assumptions must be presented. A description of all parameters used in calculations should be included.

2.3.2.4 Drainage Design Criteria

Development must meet criteria established in previous drainage studies if any exist, and reference should be made to any drainage studies of the site or adjacent properties. Any site constraints impacting drainage should be described.

The drainage design must follow the hydrologic and hydraulic criteria as established in these Standards. All criteria used for calculations shall be described, including rainfall and design storm recurrence intervals, soil classification, and imperviousness. All methods used for calculating runoff and detention discharge and storage should be indicated, as well as any other criteria or methods used in the preliminary drainage design.

A brief description of how the drainage design meets the hydraulic criteria as established in these Standards shall be included in the PDR. Include preliminary capacity analysis of all existing and proposed drainage infrastructure. Perform floodplain analysis, if required.

Describe how the project will satisfy the requirements of the County's MS4 permit, if applicable.

2.3.2.5 Drainage Facility Design

Include a discussion of the general drainage concepts of the project site. Any upstream or downstream runoff considerations should be described, as well as anticipated and proposed drainage patterns. Discuss any tables, charts, figures, or drawings included in the report, and reference plans for bordering developments as applicable.

Provide a preliminary discussion of drainage problems on-site and possible solutions. Include design flows and storage volumes needed. Describe any existing stormwater facilities and a general description of proposed stormwater conveyance and storage facilities. Details of the relationship of proposed drainage facilities to existing or planned drainage facilities in surrounding properties or developments shall be included in the report. In cases where the point of outfall or peak flow from the property is other than historic, binding agreements from affected property owners or a letter of intent permitting such discharge shall be submitted.

Discuss any variances requested from the County and how the project will meet the intent of the criteria.

2.3.2.6 Conclusions

Discuss how the project complies with all the County's stormwater and floodplain criteria, as well as FEMA floodplain regulations, if applicable. Describe how the drainage design will control runoff from the site. Include any impacts to upstream or downstream properties. If applicable, discuss how the drainage design complies with the County's MS4 permit and which post-construction design standard will be met.

2.3.2.7 References

Include references to any criteria and technical information used in preparation of the report.

2.3.2.8 Appendices

Appendices should include the following information:

- All existing and proposed runoff calculations, as well as all assumptions and parameters used.
- Preliminary hydrologic and hydraulic calculations for water quality and flood control facilities should be included.
- A copy of the relevant Flood Insurance Rate Map (FIRM) panel and any Letters of Map Revision (LOMRs) that have changed mapping since the effective date of the FIRM.
- A map of hydrologic soil groups. The map downloaded from the Natural Resource Conservation Service (NRCS) is sufficient. Include the accompanying soils report.
- Other supporting information, calculations, mapping, etc. that the applicant relied upon to prepare the report.

2.3.3 Drainage Plan

The Drainage Plan includes supporting maps and drawings of existing and proposed site conditions and drainage facilities. The drainage plan shall include a statement such as “These plans are not to be used for construction or final record” (or similar).

2.3.3.1 Overall Drainage Map

The overall drainage map should include a map of the project that includes basin and project boundaries, flow paths and drainage patterns entering, leaving, and traversing the site, as well as any major constriction such as other development along the path of drainage. Floodplain boundaries and elevations should be shown, if applicable. Include any existing or proposed stormwater facilities.

2.3.3.2 Detailed Drainage Plan

The detailed drainage plan should be of large enough scale to show all site conditions, constraints, and the design of existing and proposed drainage facilities. The plan should include contours, flow paths, design points, property lines and easements, and locations and footprints of all facilities. The County’s checklist provides additional details regarding required items to be included in the detailed drainage plan.

2.4 Final Drainage Report

The Final Drainage Report (FDR) shall be submitted for approval along with the final plat and the construction drawings. The purpose of the FDR is to update the concepts discussed in the PDR and to present design details for all proposed drainage facilities. When approved, the report will be signed by the County Engineer and shall constitute final approval of the drainage plan. The report shall include the information submitted in the PDR, with any additions, modifications, or corrections required.

The following sections describe some of the submittal requirements for an FDR.

2.4.1 Drainage Narrative

The narrative of the FDR shall include all items from the PDR, as well as the following:

2.4.1.1 Drainage Design Criteria

A detailed description of how the drainage design meets the hydraulic criteria as established in these Standards shall be included in the FDR. Provide the results of capacity analysis of existing and proposed drainage infrastructure, floodplain analyses if required, and any other drainage facility design criteria that were used.

2.4.1.2 Drainage Facility Design

The FDR shall include specific details of the drainage facility design. All final design flows and storage volumes should be included. Discuss maintenance access and aspects, as well as easements and compliance with all state, local, and federal requirements.

2.4.1.3 Appendices

In addition to the hydrologic calculations included in the PDR, the FDR shall include detailed hydraulic computations for all stormwater facilities included in the drainage design. Include capacity calculations, HGL and EGL, water surface profiles, and design details for storage and conveyance facilities.

2.4.2 Drainage Plan

The final drainage plan shall include a detailed presentation of drainage facilities. A detailed checklist including all necessary items is available in the Appendices.

2.4.3 Erosion Control Plan

This plan should indicate methods to be used during and after construction to control erosion and sediment in the development. The Erosion Control Plan shall be developed based on the guidance and criteria provided in CHAPTER 16.0 of the Standards. (As a supplement to the report, 24" x 35" drawings may be necessary to illustrate the methods and control measures to be used.)

2.4.4 Construction Plans

All storm drainage plans shall be checked for conformance with the minimum design criteria set forth in these Standards prior to approval. Prior to submittal of the final construction drawings, one complete set of prints shall be submitted for review and comment and will be returned if changes are required or recommended. Two complete sets of revised prints shall then be submitted for final approval along with the original review print.

A checklist detailing required items to be included on construction plans is available in the Appendices. Construction drawings should be completed in both plan and profile and show both existing and planned utilities and structures. All drawings must include the following statement, signed by the professional engineer:

All work shall be constructed in accordance with Larimer County Standard Specifications as provided by the County Engineer, except as noted.

APPROVED: _____

DATE: _____

2.5 As-Builts and Site Certification

All new developments within the County are required to submit for review and approval an overall site certification of the constructed drainage facilities. The overall site certification must specify the proposed and the as-built conditions of the site's drainage facilities. Engineers are required to certify that as-constructed pond volumes meet or exceed the design standards for WQCV, EURV, and detention. Any variation from the approved plans must be noted and proven to function properly within standards as in the Stormwater Design Standards. Supporting calculations to justify any variation from the approved plans shall be provided including but not limited to detention volumes, pipe capacities, and swale capacities. It is the responsibility of the owner or professional engineer to prepare and submit all required information to the State Engineers Office for any water quality SCMs.

2.5.1 Lot-Grading Certification

Individual lot or building certification may be required depending on the site design, prior to the release of a certificate of occupancy by the County Building Department. Certification of drainage facilities shall be submitted to the County Engineer at least two weeks prior to release of collateral or the release of a certificate of occupancy.

2.6 Variances

Please refer to Section 1.7 of these Standards for variance request requirements.

2.7 Certification

All drainage reports and plans must be certified that they were prepared under the direct supervision of a licensed professional engineer in the State of Colorado using the following certification:

I hereby certify that this report (plan) for the _____ (preliminary/final) drainage design of _____ was prepared by me (or under my direct supervision) for the owners thereof and meets or exceeds the criteria in the Larimer County Stormwater Design Standards.

Licensed Professional Engineer
State of Colorado No. _____
(Seal)

CHAPTER 3.0 DRAINAGE PRINCIPLES AND POLICIES

3.1 Introduction

Effective stormwater management is essential to the health and environmental and economic well-being of a community. The MHFD's guiding principles of sound drainage planning are hereby adopted by the County and inform the policies that drive the criteria of the Standards.

3.2 Principles

1. Drainage is a regional phenomenon that does not respect the boundaries between government jurisdictions or between properties. This makes it necessary to formulate programs that include both public and private involvement. Overall, the governmental entities most directly involved must provide coordination and master planning, but drainage planning must be integrated on a regional level if optimum results are to be achieved. The manner in which proposed drainage systems fit into existing regional systems must be quantified and discussed in the master plan.

2. A storm drainage system is a subsystem of the total urban water resource system. Stormwater system planning and design for any site must be compatible with comprehensive regional plans and should be coordinated with planning for land use, open space and transportation. Erosion and sediment control, flood control, site grading criteria, and water quality all closely interrelate with urban stormwater management. Any individual master plan or specific site plan should normally address all of these considerations.

3. Every urban area has an initial (i.e., minor) and a major drainage system, whether or not they are actually planned and designed. The initial drainage system, sometimes referred to as the "minor system," is designed to provide public convenience and to accommodate moderate, frequently occurring flows. The major system carries more water and operates when the rate or volume of runoff exceeds the capacity of the minor system. Both systems should be carefully considered.

4. Runoff routing is primarily a space allocation problem. The volume of water present at a given point in time in an urban region cannot be compressed or diminished. Channels and storm drains serve both conveyance and storage functions. If adequate provision is not made for drainage space demands, stormwater runoff will conflict with other land uses, result in damages, and impair or disrupt the functioning of other urban systems.

5. Planning and design of stormwater drainage systems should not be based on the premise that problems can be transferred from one location to another. Urbanization tends to increase downstream peak flow by increasing runoff volumes and velocities. Stormwater runoff can be stored and slowly released via detention facilities to manage peak flows, thereby reducing the drainage capacity required immediately downstream.

6. An urban storm drainage strategy should be a multi-objective and multi-means effort. The many competing demands placed upon space and resources within an urban region argue for a drainage management strategy that meets a number of objectives, including water quality enhancement, groundwater recharge, recreation, wildlife habitat, wetland creation, protection of landmarks/amenities, control of erosion and sediment deposition, and creation of open spaces.

7. Design of the storm drainage system should consider the features and functions of the existing drainage system. Every site contains natural features that may contribute to the management of stormwater without significant modifications. Existing features such as natural streams, depressions, wetlands, floodplains, permeable soils, and vegetation provide for infiltration, help control the velocity of runoff, extend the time of concentration, filter sediments and other pollutants, and recycle nutrients. Each development plan should carefully map and identify the existing natural system. Techniques that preserve or protect and enhance the natural features are encouraged. Good designs improve the effectiveness of natural systems rather than negate, replace or ignore them.

8. In conjunction with new development and redevelopment, coordinated efforts should be made to minimize increases in, and reduce where possible, stormwater runoff volumes, flow rates, and pollutant loads to the maximum extent practicable. Key practices include:

- The perviousness of the site and natural drainage paths should be preserved to the extent feasible. Areas conducive to infiltration of runoff should be preserved and integrated into the overall runoff management strategy for the site.
- The rate of runoff should be slowed. Preference should be given to stormwater management systems that maximize vegetative and pervious land cover. These systems will promote infiltration, filtering and slowing of the runoff. It should be noted that, due to the principle of mass conservation, it is virtually impossible to prevent increases in post-development runoff volumes for all storm events when an area urbanizes. Existing stormwater regulations typically require control of peak flows to predevelopment levels to the maximum extent practicable, and increasingly, regulatory agencies are implementing requirements focused on the control of runoff volumes for smaller, frequently occurring events. Increased flow volumes may not cause flooding problems if a watershed has a positive outfall to a stream or river; however, increases in runoff volumes may cause problems for small, enclosed watersheds (i.e. draining to a lake) or into streams of limited capacity. Increases in runoff volumes, if not appropriately managed, can also adversely affect stream stability.
- Pollution control is best accomplished by implementing a series of measures, which can include source controls, minimizing directly connected impervious area, and construction of on-site and regional facilities to control both runoff and pollution. Implementing measures that reduce the volume of runoff produced by frequently occurring events through infiltration and disconnection of impervious areas is one of the most effective means for reducing the pollutant load delivered to receiving waters.

9. The stormwater management system should be designed beginning with the outlet or point of outflow from the project, giving full consideration to downstream effects and the effects of offsite flows entering the system. The downstream conveyance system should be evaluated to ensure that it has sufficient capacity to accept design discharges without adverse upstream or downstream impacts such as flooding, stream bank erosion, and sediment deposition. In addition, the design of a drainage system should take into account the runoff from upstream sites, recognizing their future development runoff potential (e.g., imperviousness).

10. The stormwater management system requires regular maintenance. Failure to provide proper maintenance reduces both the hydraulic capacity and pollutant removal efficiency of the system. The key to effective maintenance is clear assignment of responsibilities to an established entity and a regular schedule of inspections to determine maintenance needs and to ensure that required maintenance is conducted. Local maintenance capabilities should be a consideration when selecting specific design criteria for a given site or project.

11. Floodplains should be preserved whenever feasible and practicable. Nature has claimed prescriptive easement for floods, via its floodplains, that cannot be denied without public and private cost. Floodplain encroachment must not be allowed unless competent engineering and planning have proven that flow capacity is maintained, risks of flooding are defined, and risks to life and property are strictly minimized. Preservation of floodplains is a policy of MHFD to manage flood hazards, preserve habitat and open space, create a more livable urban environment, and protect the public health, safety, and welfare (White 1945).

12. Reserve sufficient right-of-way for lateral movement of incised floodplains. Whenever an urban floodplain is contained within a narrow non-engineered channel, its lateral movement over time can cause extensive damage to public and private structures and facilities. For this reason, whenever such a condition exists, it is recommended that, at a minimum, the channel be provided with grade control structures and a right-of-way corridor be preserved of a width corresponding to normal depth calculations for the future stable channel geometry, plus maintenance access requirements.

3.3 Planning Policies

New development and redevelopment have the potential to impact drainage, both upstream and downstream. Those impacts can be analyzed, and solutions can be developed to reduce, minimize or eliminate impacts as part of the drainage planning process. The County's planning policies include the following:

1. Require drainage planning for all new development, minor expansion, change of use, or major redevelopment, as defined in the Larimer County Land Use Code. Drainage

planning may include, but is not necessarily limited to, preparation of engineering reports and development plans in accordance with requirements of these Standards.

Types of Projects in the County Requiring Drainage Planning*

New Development: Any construction activity or site alteration on a site that has not been previously developed.

Minor Expansion: Any development activity that includes the following: 1) Expansion of a mixed use-building by more than 2,000 square feet of non-residential space or the lesser of more than 10 dwelling units or 10% of the number of dwelling units; or 2) Expansion of a non-residential building by the greater of either 2,000 square feet or more than 20% of the total square footage of the building.

Change of Use: Any change of use that involves or requires on-site or off-site improvements, including but not limited to parking; landscaping, screening, or buffering; drainage facilities; outdoor uses on the lot, including sales, display, and storage.

Major Redevelopment: Any development activity on a mixed-use or non-residential site that involves change to 75 percent or more of the square footage of a primary structure. Major redevelopment shall be measured cumulatively over a rolling five-year period in the same ownership, starting with the applicant's most recent development application.

*All of these types of developments are collectively referred to as "**Projects**" throughout these Standards

2. Require implementation of solutions for potential drainage impacts so as not to transfer drainage problems from one location to another.

Comprehensive and multi-jurisdictional drainage planning is a successful approach that reduces overall drainage impacts and aims to distribute stormwater management responsibilities equitably throughout a watershed. In addition, the County encompasses many cities and towns that have developed their own drainage criteria and watershed master plans.

3. Encourage and cooperate with other local and regional agencies on the development and/or implementation of watershed-scale drainage planning and policies. This policy shall include adhering to Agreements (existing and/or future) with those agencies that have established drainage criteria and policies for their respective Growth Management Areas (e.g., City of Fort Collins, City of Loveland, etc.).

Drainage planning can present opportunities that benefit other societal needs such as transportation, recreation, open space, water quality, and others. Coordination among both private and public entities, and within various departments of the County, may be necessary to accomplish these multi-objective goals.

4. Consider stormwater runoff and drainage solutions as a potential resource for other social, environmental, and economic benefits and, where possible, encourage the development of drainage plans that incorporate those other benefits.

3.4 Technical/Design Standards Policies

The Standards presented herein establish guidelines, criteria and methods for effective stormwater management planning and design. The County’s technical/design policies include the following:

1. Require drainage planning and design be conducted according to the Standards presented in this document.

The County has very diverse characteristics (e.g., land use, population density, topography, geology) that effect how stormwater may be managed in different locations. It is not always feasible or responsible to apply drainage criteria developed for highly urbanized areas to areas that are not.

2. Recognize the need for different drainage design criteria for “rural” and “urban” areas, where allowable by local, state and federal regulations.

Rural vs. Urban Areas as Defined by the Larimer County Land Use Code*

Rural areas are characterized by rural residential development with accessory agricultural and minimal infrastructure and support services.

Urban areas are characterized by a mix of residential, commercial, and industrial development.

In reality, urbanization occurs over a spectrum of imperviousness from low-density rural areas to denser suburban areas to very dense downtown areas. In general, urban areas are those within the County’s Growth Management Area and rural areas are those zoned as agricultural or rural land uses.

*A zoning map is available on the Larimer County Planning Department webpage.

Drainage design requires consideration of the frequency and extent of disruptions and damage that may occur from storm events of different magnitudes. Accordingly, these Standards include design requirements for both a minor (initial) storm event and the major storm event. Minor storm event criteria are intended to minimize disruptions from more frequently occurring events. Major storm event criteria are intended to minimize damages from larger, less-frequent events.

3. Require drainage systems that are designed for both a minor (initial) storm event and a major storm event. The minor storm event shall vary based on infrastructure type and

location (generally 2-year to 10-year return period storm event). The major storm event shall be the 100-year return period storm event.

The disruptions and damages mentioned above are most often associated with streets and roadways. Drainage can be conveyed directly on streets/roadways (e.g., curb and gutter), adjacent to streets/roadways (e.g., roadside swales) or below streets/roadways (e.g., pipes and culverts). These Standards establish reasonable limits for the interactions of drainage designs on streets/roadways.

4. Recognize that streets and roadways have the primary purpose of serving traffic needs and that street/roadway drainage Criteria serve to balance traffic needs, public safety, and costs of constructing and maintaining drainage infrastructure.

Development and redevelopment generally increase the rate and volume of runoff from a site, which can lead to flooding and stream degradation downstream. Stormwater detention can be used to reduce those rates and volumes closer to predevelopment conditions.

5. Require all new development and redevelopment to provide aboveground stormwater detention following the MHFD's "full-spectrum detention" approach.

Portions of the County fall within the State of Colorado's municipal separate storm sewer system (MS4) boundaries. Development and redevelopment projects conducted within those boundaries must adhere to certain requirements of the State's MS4 permit, including implementation of post-construction stormwater control measures (aka permanent water quality treatment facilities).

6. Require all new development and redevelopment within the County's MS4 boundaries to provide permanent water quality treatment according to the Criteria presented in the Standards.

3.5 Operation and Maintenance Policies

Drainage infrastructure requires proper maintenance in order to maintain its function. Typical maintenance activities include sediment and debris removal, vegetation upkeep and erosion control. It is important that all infrastructure be accessible for maintenance. The County's operation and maintenance policies include the following:

1. Development-wide stormwater conveyance facilities shall only be situated in an outlet, common area lot, or road Right-of-Way/Easement. Drainage easements shall only be used to convey stormwater drainage from an individual lot to a dedicated development-wide stormwater facility. Approved grading and drainage plans shall not be altered unless prior approval from the County Engineer is obtained. This shall be documented and memorialized in HOA documents or as part of a recorded maintenance agreement.

2. The owners of all stormwater management facilities and infrastructure are responsible for maintenance unless it is documented that another party shall be responsible for maintenance.
3. Require maintenance access be provided to all stormwater management facilities.
4. The County reserves the right to enter a property to maintain stormwater management facilities if the owner fails to do so, and the owner shall be responsible for reimbursing the County for those costs.

3.6 Floodplain Management Policies

The County participates in the National Flood Insurance Program (NFIP). The NFIP establishes minimum criteria for development within floodplains and participation in the program allows property owners to obtain flood insurance from the federal government. The County's floodplain management policies include the following:

1. The County implements and enforces floodplain development regulations that meet or exceed the minimum standards of the NFIP, Section 44, Parts 59, 60, 65, 70 of the Federal Code of Regulations.

Further, the Colorado Water Conservation Board has issued floodplain rules and regulations for all of Colorado.

2. The County implements and enforces floodplain development regulations that meet or exceed the rules, regulations, and standards of the Colorado Water Conservation Board.

CHAPTER 4.0 FLOODPLAINS

4.1 Introduction

This chapter provides an overview of the County's Floodplain Rules and Regulations, as described in the Larimer County Floodplain Development Guide. The complete guidance document may be found on the County's website. For additional information, consult the Larimer County Land Use Code (LCLUC), Article 12: *Floodplain*.

4.2 Floodplain Regulations

In order to participate in the National Flood Insurance Program (NFIP), the County has adopted and enforces floodplain rules and regulations for development within regulatory floodplains in the County. The following floodplain regulations apply within the County:

- Article 12 of the Larimer County Land Use Code (www.larimer.org/engineering/floodplains),
- National Flood Insurance Act of 1968,
- 44 Code of Federal Regulations §65.3 (44 CFR §65.3),
- Section 2 Colorado Code of Regulations 408-1 (2 CCR 408-1), and
- Colorado Water Conservation Board (CWCB) Rules and Regulations for Regulatory Floodplains in Colorado.

4.3 Definitions

Common floodplain-related items and terms are defined below. Additional definitions may be found in the LCLUC.

100-Year Flood: A flood event having a 1-percent chance of being equaled or exceeded during any given year. The term does not imply that the flood will necessarily happen only once every 100 years.

500-Year Flood: A flood event having a 0.2-percent chance of being equaled or exceeded during any given year. The term does not imply that the flood will necessarily happen only once every 500 years.

Base Flood Elevation (BFE): The water surface elevation for the flood event associated with a 1% chance of being equaled or exceeded in any given year. Therefore, BFEs represent the 100-year flood water surface elevations.

Certification of No-Rise: Statement by the professional engineer certifying that the proposed development activities in the floodway will not cause an increase in BFE, floodway elevations, or impact the floodway widths.

Conditional Letter of Map Revision (CLOMR): Federal Emergency Management Agency’s comment on a proposed project, which does not revise an effective floodplain map, that would, upon construction, affect the hydrologic or hydraulic characteristics of a flooding source and thus result in the modification of the existing regulatory floodplain.

FEMA: Federal Emergency Management Agency, the agency responsible for administering the National Flood Insurance Program.

Flood Fringe: The portions of the Floodplain Overlay District (see Section 4.4) that are within flood zones associated with a 1% annual chance of occurrence but not located in a floodway zone.

Floodplain or Flood-Prone Areas: Any land area susceptible to being inundated as the result of a flood, including the area of land over which floodwater would flow from the spillway of a reservoir. This also includes the inundation pools for reservoirs.

Floodway: Those portions of the Floodplain Overlay District (see Section 4.4) that must be reserved from development or encroachment in order to discharge the 1% Annual Chance Flood Event without cumulatively increasing the water surface elevation more than 0.5 feet (or other height specified by the County or local community), including the channel of a river or other watercourse and any adjacent floodplain areas that must be kept free of development and other encroachments.

Letter of Map Revision (LOMR): An official amendment to the currently effective FEMA map, issued by FEMA, which changes flood zones, delineations, and elevations.

4.4 Floodplain Overlay District

For purposes of regulation, the County has established a zoning district which includes all its regulatory floodplains called the “Floodplain Overlay District,” or FPO District.

The FPO District includes the FEMA Floodplain, Best Available Floodplain, Municipal Floodplain, Cache La Poudre Growth Management Area Floodplain, and Larimer County Flood-Prone Areas. Detailed descriptions of, and instructions for viewing, the FPO District boundaries can be found in the County’s Floodplain Development Guide. Each floodplain contains several different flood zones, each with different regulations. Refer to the County’s Floodplain Development Guide and LCLUC for detailed information regarding each zone.

The FPO District can be viewed using the online floodplain map at:

<https://maps1.larimer.org/gvh/?Viewer=LIL&run=Theme&theme=Flood%20Information>

If the above link does not work, search the County’s floodplain website.

4.5 Floodplain Development Permits

All development within the FPO District is required to obtain a Floodplain Development Permit (FDP). Floodplain development is defined as any manmade change to improved and unimproved real estate, including, but not limited to, buildings or other structures, mining, dredging, filling, grading, paving, excavating or drilling operations.

4.5.1 Exclusions

Please refer to the County's Floodplain Development Guide or LCLUC for details regarding exclusions to the FDP requirement.

4.5.2 Standards

In addition to these Standards, all development within the FPO District must meet requirements as defined in the following documents:

- Larimer County Floodplain Development Guide,
- Larimer County Rural Area Road Standards,
- Larimer County Urban Area Street Standards,
- Larimer County Land Use Code (Article 12.0 *Floodplain*), and
- FEMA Technical Bulletins and Technical Documents (FEMA Guidance).

4.5.3 Permit Process

The process for obtaining an FDP begins with the submittal of an FDP Application and other submittal items needed to evaluate whether floodplain requirements are adequately met by the project. Floodplain development projects are categorized by structural or non-structural projects and may need to be evaluated by the County's Flood Review Board depending on the nature of the project. The process for obtaining an FDP is shown in Figure 4-1.

4.5.4 Submittals

The FDP Application may be accessed on the Larimer County Floodplains website: <https://www.larimer.org/engineering/floodplains>.

Submittal requirements for an FDP Application may include any/all of the following and may require certification by a licensed professional engineer:

- Construction Plans,
- Hydraulic Study,
- Certificates (No-Rise Certificate, No Adverse Impact Certificate, FEMA Elevation Certificate),
- Floodproofing Design Specifications,
- Repair of Substantial Damage or Substantial Improvement (SI/SD) Submittals,

- Ownership Documentation or Right-of-Access Agreements,
- Federal, State, and Local Permits, and
- Other Requirements.

Permit close-out submittal requirements for an FDP Application may include any/all of the following and may require certification by a licensed professional engineer:

- As-built plans
- Certificates (No-Rise Certificate, No Adverse Impact Certificate, FEMA Elevation Certificate)
- Letter of Compliance

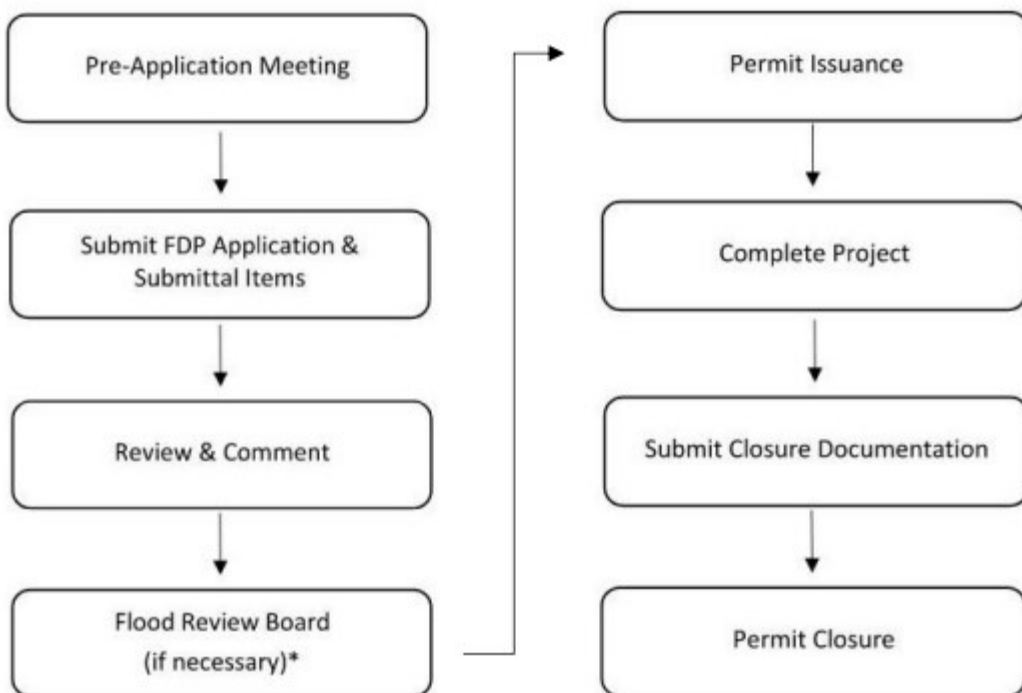

Figure 4-1. Floodplain Development Permit Flowchart (From Larimer County Floodplain Development Guide)

4.5.5 Flood Review Board

Certain floodplain permit applications require review and recommendation by the Larimer County Flood Review Board (FRB). The FRB is appointed by the Board of County Commissioners and makes recommendations to the County Engineer regarding variance requests, interpretation of the LCLUC, map amendment proposals, Floodplain Project Reviews, and provides general guidance regarding floodplain development and other flood related topics.

Projects requiring review by the FRB need to follow the processes outlined in the Floodplain Development Guide.

4.6 Additional Resources

Links to additional resources for understanding floodplains, flood risk, and development regulations may be found in the Larimer County Floodplains website and Floodplain Development Guide.

CHAPTER 5.0 RAINFALL

5.1 Introduction

This chapter provides methods for obtaining rainfall data and generating rainfall design storms to be used for hydrologic runoff analysis within the County.

Rainfall data is based on the *National Oceanic and Atmospheric Administration Atlas 14, Precipitation-Frequency Atlas of the United States, Volume 8* (NOAA, 2013), which is referred hereinto as “NOAA Atlas 14.” NOAA Atlas 14 is a precipitation frequency study released in 2013 for Colorado. It leverages over 30 years of additional precipitation data that has been recorded since the previous NOAA Atlas 2 studies were prepared in the 1970s. Approximately 15 rain gages within the County were used for NOAA Atlas 14 analysis, with various periods of record ranging from 1941 through 2011. NOAA Atlas 14 results are also readily available online using an interactive map to retrieve rainfall data at any location. MHFD and many other Colorado communities have adopted NOAA Atlas 14 since it was published.

The County Engineer may allow the use of other rainfall data if required by existing master drainage plans.

5.2 Retrieving Data from NOAA Atlas 14

Rainfall depth and intensity tables and graphs can be retrieved directly from the NOAA Atlas 14 website using the following procedures:

1. Go to the NOAA Atlas 14 website for Colorado.
(https://hdsc.nws.noaa.gov/hdsc/pfds/pfds_map_cont.html?bkmrk=co)
2. Select the project location by entering the latitude and longitude coordinates, address, or by using the point and click function on the interactive map.
3. Select either *Precipitation depth* (for developing design storms) or *Precipitation intensity* (for the intensity-duration-frequency curves) as the *Data type* and specify *Partial duration* as the *Time series type*. A partial duration series-based precipitation frequency estimates table appears below the map with 90% confidence intervals indicated.
4. Download the table of precipitation depth or intensity estimates, with or without 90% confidence intervals, by selecting the *Submit* button below the output table.
5. Use the *Print page* button to generate a report showing the rainfall data and location maps and provide that report with the submittals. An example of point precipitation data for an area near Red Feather Lakes is provided at the end of this chapter.

5.3 Intensity-Duration-Frequency

Rainfall intensity-duration-frequency data are needed for use in the Rational Method. NOAA Atlas 14 provides intensity values for storms of 5, 10, 15, 30, 60, and 120-minute duration (as well as longer) and return periods of 1, 2, 5, 10, 25, 50, 100, 200, 500 and 1000 years. The user

should interpolate between these values to obtain intensities for a storm duration falling in between those provided.

5.4 Design Storm Distributions

Design storms to be used with the Colorado Urban Hydrograph Procedure shall be generated according to procedures outlined in the *Rainfall* chapter of the MHFD Manual. The point-rainfall depths shall be obtained from NOAA Atlas 14 according to the procedures above. Note that depth-area-reduction factors may apply for contributing areas greater than 2 square miles. Table 5-1 below shows the 2-hour design storm distribution for 5-minute increments. The Excel-based workbooks CUHP-2000 and MHFD-Detention, both provided by MHFD, will automatically generate hyetographs for multiple return periods based on drainage area and one-hour point rainfall values. These workbooks are discussed in more detail in Chapter 6 *Runoff* and Chapter 14 *Detention* of the Standards.

Table 5-1. from MHFD Manual showing 2-hour design storm distributions based on 1-hour precipitation depths

Time Minutes	Percent of 1 Hour Precipitation Depth (%)				
	2-Year	5-Year	10-Year	25- and 50-Year	100- and 500-Year
5	2.0	2.0	2.0	1.3	1.0
10	4.0	3.7	3.7	3.5	3.0
15	8.4	8.7	8.2	5.0	4.6
20	16.0	15.3	15.0	8.0	8.0
25	25.0	25.0	25.0	15.0	14.0
30	14.0	13.0	12.0	25.0	25.0
35	6.3	5.8	5.6	12.0	14.0
40	5.0	4.4	4.3	8.0	8.0
45	3.0	3.6	3.8	5.0	6.2
50	3.0	3.6	3.2	5.0	5.0
55	3.0	3.0	3.2	3.2	4.0
60	3.0	3.0	3.2	3.2	4.0
65	3.0	3.0	3.2	3.2	4.0
70	2.0	3.0	3.2	2.4	2.0
75	2.0	2.5	3.2	2.4	2.0
80	2.0	2.2	2.5	1.8	1.2
85	2.0	2.2	1.9	1.8	1.2
90	2.0	2.2	1.9	1.4	1.2
95	2.0	2.2	1.9	1.4	1.2
100	2.0	1.5	1.9	1.4	1.2
105	2.0	1.5	1.9	1.4	1.2
110	2.0	1.5	1.9	1.4	1.2
115	1.0	1.5	1.7	1.4	1.2
120	1.0	1.3	1.3	1.4	1.2
Totals	115.7%	115.7%	115.7%	115.6%	115.6%

5.5 Example

Obtain the 5-year rainfall intensity value to use in the Rational Method for a 45-acre watershed in the Red Feather Lakes area. $T_c = 17$ minutes.

1. Go to the NOAA Atlas 14 website and select the location on the interactive map (Figure 5-1).

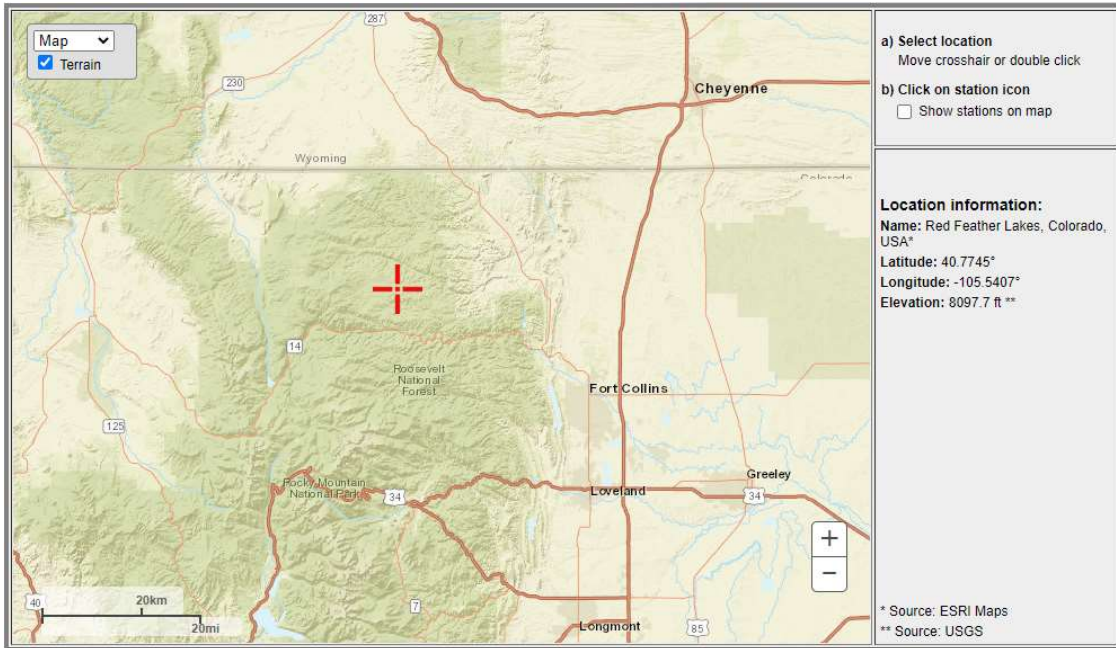

Figure 5-1. Location near Red Feather Lakes selected for point precipitation estimates using NOAA Atlas 14

2. Select Precipitation intensity, English units, and Partial duration time series.
3. Download the table of precipitation frequency estimates (Figure 5-2).
4. Create a graph of intensity-duration-frequency values (Figure 5-3).
5. Interpolate to find 5-year, 17-minute intensity.
 - a. Find 5-year, 15-minute intensity and 5-year, 30-minute intensity from precipitation table downloaded from NOAA

Duration (minutes)	5-year Intensity (in/hr)
15	2.51
30	1.62

- b. Use Equation 1 for linear interpolation:

$$y = y_1 + (x - x_1)(y_2 - y_1)/(x_2 - x_1) \quad (1)$$

Where:

$y =$ 5-year, 17-minute intensity
 $x =$ 17 minutes
 $x_1 =$ Duration 1
 $x_2 =$ Duration 2
 $y_1 =$ Intensity 1
 $y_2 =$ Intensity 2

c. $I = 2.4$ in/hr

PDS-based precipitation frequency estimates with 90% confidence intervals (in inches/hour) ¹										
Duration	Average recurrence interval (years)									
	1	2	5	10	25	50	100	200	500	1000
5-min	2.64 (2.03-3.43)	3.22 (2.47-4.19)	4.22 (3.23-5.51)	5.10 (3.89-6.71)	6.40 (4.75-8.87)	7.46 (5.41-10.5)	8.58 (6.02-12.5)	9.77 (6.60-14.7)	11.4 (7.44-17.8)	12.8 (8.08-20.1)
10-min	1.94 (1.49-2.51)	2.36 (1.81-3.07)	3.09 (2.36-4.04)	3.74 (2.85-4.91)	4.69 (3.48-6.49)	5.47 (3.96-7.69)	6.28 (4.41-9.13)	7.15 (4.83-10.8)	8.37 (5.44-13.0)	9.34 (5.91-14.7)
15-min	1.57 (1.21-2.05)	1.92 (1.47-2.50)	2.51 (1.92-3.28)	3.04 (2.32-3.99)	3.81 (2.83-5.28)	4.44 (3.22-6.26)	5.11 (3.58-7.42)	5.82 (3.93-8.74)	6.80 (4.43-10.6)	7.59 (4.80-12.0)
30-min	1.02 (0.782-1.32)	1.24 (0.950-1.61)	1.62 (1.24-2.12)	1.96 (1.49-2.57)	2.46 (1.83-3.41)	2.87 (2.08-4.04)	3.30 (2.32-4.80)	3.76 (2.54-5.66)	4.41 (2.87-6.86)	4.92 (3.11-7.77)
60-min	0.629 (0.483-0.817)	0.752 (0.578-0.979)	0.976 (0.748-1.27)	1.18 (0.900-1.55)	1.49 (1.12-2.09)	1.76 (1.28-2.49)	2.04 (1.44-2.98)	2.35 (1.59-3.55)	2.79 (1.82-4.36)	3.15 (2.00-4.97)
2-hr	0.374 (0.290-0.482)	0.443 (0.344-0.572)	0.571 (0.441-0.740)	0.692 (0.532-0.900)	0.879 (0.665-1.22)	1.04 (0.766-1.46)	1.22 (0.867-1.77)	1.41 (0.966-2.12)	1.69 (1.12-2.62)	1.92 (1.23-3.00)
3-hr	0.278 (0.217-0.357)	0.324 (0.252-0.416)	0.413 (0.321-0.532)	0.500 (0.388-0.647)	0.638 (0.488-0.887)	0.761 (0.564-1.07)	0.896 (0.643-1.30)	1.05 (0.723-1.57)	1.27 (0.843-1.96)	1.45 (0.934-2.25)
6-hr	0.171 (0.134-0.217)	0.194 (0.152-0.247)	0.242 (0.190-0.309)	0.291 (0.227-0.374)	0.373 (0.289-0.516)	0.446 (0.335-0.624)	0.529 (0.384-0.761)	0.623 (0.435-0.925)	0.761 (0.512-1.17)	0.877 (0.570-1.35)
12-hr	0.104 (0.083-0.131)	0.117 (0.093-0.148)	0.144 (0.114-0.183)	0.172 (0.135-0.219)	0.219 (0.171-0.300)	0.261 (0.198-0.361)	0.308 (0.226-0.439)	0.362 (0.255-0.532)	0.442 (0.300-0.669)	0.508 (0.334-0.773)
24-hr	0.062 (0.050-0.078)	0.071 (0.057-0.089)	0.088 (0.070-0.110)	0.105 (0.083-0.132)	0.132 (0.104-0.178)	0.156 (0.119-0.213)	0.183 (0.135-0.257)	0.213 (0.152-0.309)	0.257 (0.176-0.385)	0.294 (0.195-0.442)
2-day	0.036 (0.029-0.044)	0.042 (0.034-0.051)	0.052 (0.042-0.065)	0.062 (0.050-0.078)	0.078 (0.062-0.104)	0.092 (0.071-0.124)	0.107 (0.080-0.148)	0.124 (0.089-0.177)	0.148 (0.102-0.218)	0.167 (0.112-0.249)
3-day	0.026 (0.021-0.032)	0.030 (0.024-0.037)	0.037 (0.030-0.046)	0.044 (0.036-0.055)	0.055 (0.044-0.073)	0.065 (0.050-0.087)	0.075 (0.056-0.104)	0.087 (0.063-0.124)	0.104 (0.072-0.152)	0.118 (0.079-0.174)
4-day	0.021 (0.017-0.025)	0.024 (0.019-0.029)	0.029 (0.024-0.036)	0.035 (0.028-0.043)	0.043 (0.034-0.057)	0.050 (0.039-0.067)	0.058 (0.044-0.080)	0.067 (0.049-0.095)	0.080 (0.056-0.117)	0.091 (0.062-0.133)
7-day	0.014 (0.011-0.017)	0.016 (0.013-0.019)	0.019 (0.016-0.023)	0.022 (0.018-0.027)	0.027 (0.022-0.035)	0.031 (0.025-0.041)	0.036 (0.027-0.049)	0.041 (0.030-0.058)	0.048 (0.034-0.070)	0.054 (0.037-0.079)
10-day	0.011 (0.009-0.013)	0.012 (0.010-0.015)	0.015 (0.012-0.018)	0.017 (0.014-0.021)	0.021 (0.017-0.027)	0.024 (0.019-0.031)	0.027 (0.021-0.036)	0.031 (0.022-0.043)	0.036 (0.025-0.051)	0.040 (0.027-0.058)
20-day	0.007 (0.006-0.009)	0.008 (0.007-0.010)	0.010 (0.008-0.012)	0.011 (0.009-0.013)	0.013 (0.011-0.017)	0.015 (0.012-0.019)	0.016 (0.012-0.022)	0.018 (0.013-0.025)	0.020 (0.015-0.029)	0.022 (0.016-0.032)
30-day	0.006 (0.005-0.007)	0.007 (0.005-0.008)	0.008 (0.006-0.009)	0.009 (0.007-0.011)	0.010 (0.008-0.013)	0.011 (0.009-0.014)	0.013 (0.010-0.016)	0.014 (0.010-0.019)	0.015 (0.011-0.021)	0.017 (0.012-0.024)
45-day	0.005 (0.004-0.006)	0.005 (0.004-0.006)	0.006 (0.005-0.008)	0.007 (0.006-0.009)	0.008 (0.007-0.010)	0.009 (0.007-0.011)	0.010 (0.008-0.013)	0.011 (0.008-0.014)	0.012 (0.008-0.016)	0.013 (0.009-0.018)
60-day	0.004 (0.003-0.005)	0.005 (0.004-0.005)	0.005 (0.005-0.006)	0.006 (0.005-0.007)	0.007 (0.006-0.009)	0.008 (0.006-0.010)	0.008 (0.006-0.011)	0.009 (0.007-0.012)	0.010 (0.007-0.014)	0.010 (0.007-0.015)

¹ Precipitation frequency (PF) estimates in this table are based on frequency analysis of partial duration series (PDS). Numbers in parenthesis are PF estimates at lower and upper bounds of the 90% confidence interval. The probability that precipitation frequency estimates (for a given duration and average recurrence interval) will be greater than the upper bound (or less than the lower bound) is 5%. Estimates at upper bounds are not checked against probable maximum precipitation (PMP) estimates and may be higher than currently valid PMP values. Please refer to NOAA Atlas 14 document for more information.

Estimates from the table in CSV format:

Figure 5-2. Output table of precipitation intensity estimates including 90% confidence intervals produced for a point near Red Feather Lakes using NOAA Atlas 14

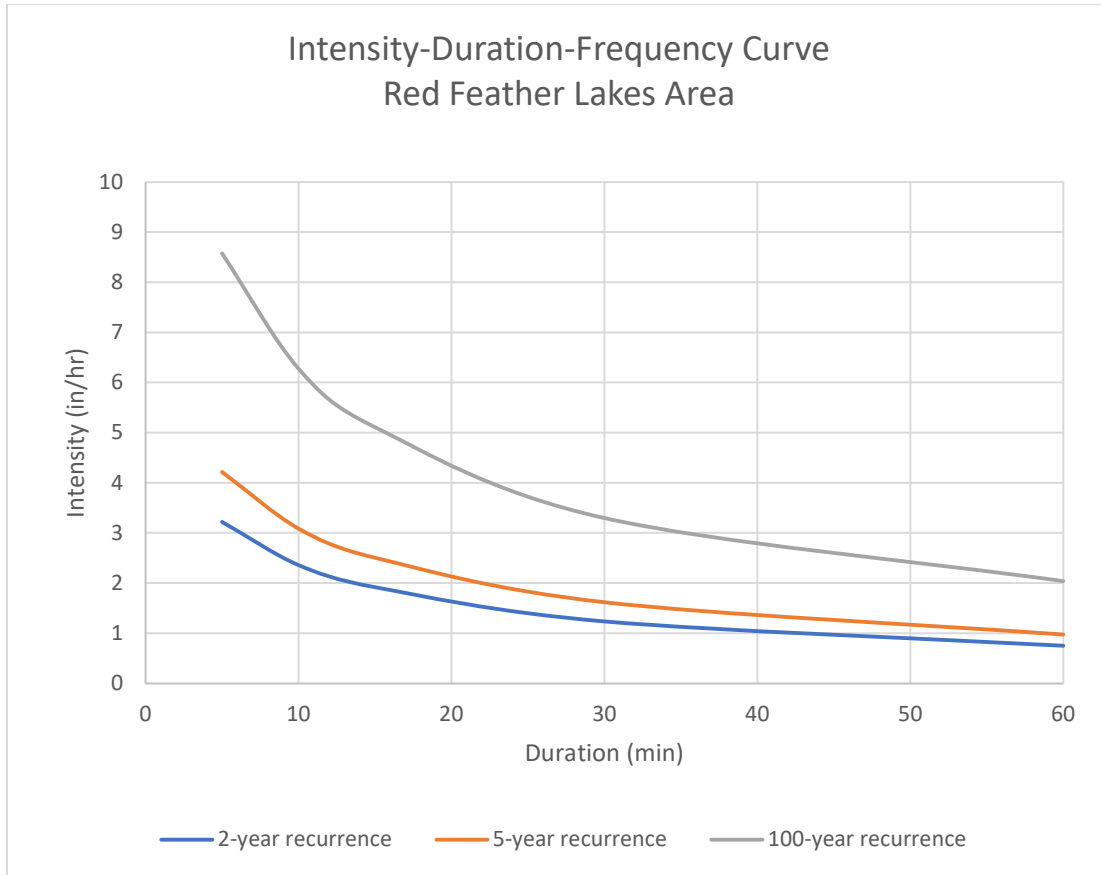

Figure 5-3. Intensity-duration-frequency curve generated from NOAA Atlas 14 data for a point outside Red Feather Lakes

5.6 Submittal Requirements

Drainage reports shall include the following information related to rainfall:

- Map showing NOAA Atlas 14 rainfall location,
- Summary table and/or figures of relevant precipitation values and return intervals, and
- Summary table and/or figures of design storms.

5.7 References

National Oceanic and Atmospheric Administration (NOAA), 2013. NOAA Atlas 14 Precipitation-Frequency Atlas of the United States, Volume 8, Version 2.0.

CHAPTER 6.0 RUNOFF

6.1 Introduction

This chapter provides design criteria and procedures to be used for determining runoff peaks and volumes for the design of stormwater drainage infrastructure in the County.

The selection of the appropriate criteria and procedures will be based on the project size, location and/or type. Many small projects can be completed using the Rational Method where only peak discharges are computed. Larger projects with complex routing and those that require detention design will need to use one of the methods that generate runoff hydrographs. The Colorado Urban Hydrograph Procedure (CUHP) and EPA Stormwater Management Model (SWMM) are most applicable for hydrologic modeling in urban areas. The Hydraulic Engineering Center – Hydrologic Modeling System (HEC-HMS) includes other methods that can be applied in both urban and rural watersheds. In some situations, it may be possible to use streamflow measurements or estimates from other sources. Table 6-1 is a summary of the methods discussed in this chapter and general guidelines for when each method can be used. The following sections discuss each method in more detail and provide additional criteria.

Table 6-1. Accepted Hydrologic Runoff Methods in Larimer County

Runoff Calculation Method	Application Criteria
Rational Method	<ul style="list-style-type: none"> • May be used in simple drainage basins of less than 90 acres. • Should not be used when routing is required or parameters other than peak flow are warranted.
CUHP	<ul style="list-style-type: none"> • Urban areas only • Required for basins greater than 90 acres, may be used for smaller basins • Should be used in conjunction with SWMM when routing of the hydrograph is required.
SWMM	<ul style="list-style-type: none"> • Used for routing of runoff hydrographs generated from CUHP or HEC-HMS • May be used for generating runoff hydrographs in Fort Collins Growth Management Area
HEC-HMS	<ul style="list-style-type: none"> • May be used for rural areas • Includes multiple runoff hydrograph methods (including Soil Conservation Service Curve Number) • Also includes routing methods
Streamflow Statistical Analysis	<ul style="list-style-type: none"> • Used for bridge/culvert design on streams with existing gages • At least 30 years of annual maximum peak discharge data required
StreamStats	<ul style="list-style-type: none"> • Limited application for small, private projects such as culverts/bridges. Must be approved for use by County Engineer.

The percent impervious values that shall be used for different land uses and surfaces are provided in Table 6-2. If an appropriate land use or surface is not provided in Table 6-2, the engineer shall

use values from the MHFD Manual or another relevant source (subject to acceptance by the County Engineer).

Table 6-2: Percent imperviousness values to be used in hydrologic modeling

Land Use or Surface Characteristics	Percentage Imperviousness (%)
Business:	
Downtown Areas	95
Suburban Areas	75
Residential Lots (lot area only):	
Single-family	
2.5 acres or larger	12
0.75-2.49 acres	20
0.25-0.74 acres	30
0.24 acres or less	45
Apartments/Multi-Family	75
Industrial:	
Light Areas	80
Heavy Areas	90
Parks, cemeteries:	10
Schools:	55
Railroad yard areas:	50
Undeveloped Areas:	
Historic flow analysis	2
Greenbelts, agricultural	2
Offsite flow analysis (when land use not defined)	45
Streets/Roadways:	
Paved	100
Recycled Asphalt	100
Gravel (packed)	40
Driveways/Sidewalks:	90
Roofs:	90
Lawns:	2

6.2 Rational Method

The Rational Method may be used to compute peak flows for projects with a contributing area less than 90 acres and which do not have complex drainage systems (e.g., different flow paths for different flow rates). The overall contributing area should be subdivided into smaller subbasins so that hydrologic losses are homogeneous and uniform within each subbasin and to provide adequate resolution for design of drainage infrastructure. The user should read and understand the general applications, limitations and assumptions of the Rational Method as discussed in the *Runoff* chapter of the MHFD Manual.

Application of the Rational Method shall follow the design procedures provided in the *Runoff* chapter of the MHFD Manual. Use of the MHFD's UD-Rational software program is preferred, however, the use of other spreadsheet programs and/or well-organized written calculations are also acceptable.

6.3 Colorado Urban Hydrograph Procedure (CUHP)

The Colorado Urban Hydrograph Procedure (CUHP) is a unit hydrograph method developed for application in urban watersheds along the Front Range of Colorado. It generates a full runoff hydrograph from each subcatchment using design storm rainfall distributions and various watershed parameters. Routing of the subcatchment runoff hydrographs is performed using the EPA Stormwater Management Model (SWMM) discussed in the following section.

CUHP is available from the MHFD as a Microsoft Excel-based program. Application of CUHP, including selection of parameter values, shall follow the procedures provided in the *Runoff* chapter of the MHFD Manual and the CUHP User's Manual.

6.4 EPA Stormwater Management Model (SWMM)

SWMM is a computer program that simulates stormwater runoff and flow routing through urban watersheds. Runoff hydrographs are generated by a non-linear reservoir routing algorithm using design storm rainfall distributions and various watershed parameters. The County prefers that CUHP is used for generating runoff hydrographs for urban watersheds; however, exceptions may be necessary if the project is within the City of Fort Collins Growth Management Area.

SWMM's hydraulic routing features include open channels, storm pipes, culverts, and detention basins. When used in conjunction with CUHP, SWMM imports runoff hydrographs directly from the CUHP/SWMM interface file and applies them to the corresponding SWMM routing node. SWMM models should be run using the kinematic wave routing method. Use of the dynamic wave routing method may be approved by the County Engineer if the applicant can demonstrate the need for doing so. The steady-state routing method is not allowed under any circumstances. The SWMM model can be downloaded from the EPA Stormwater Management Model website.

<https://www.epa.gov/water-research/storm-water-management-model-swmm>

6.5 Hydrologic Engineering Center – Hydrologic Modeling System (HEC-HMS)

The HEC-Hydrologic Modeling System (HMS) is a computer program with several different methods for generating runoff hydrographs and routing hydrographs through various conveyance elements. Although the County will accept any of the rainfall-runoff methods included in HEC-HMS, the Soil Conservation Service (SCS) Curve Number Loss Method and SCS Unit Hydrograph Method are commonly used and familiar to most engineers. The appropriate

routing method must be selected by the user based on conditions being modeled. It is recommended that the user discuss which methods to use with the County Engineer prior to proceeding with the modeling work.

<https://www.hec.usace.army.mil/software/hech-hms/>

6.6 Streamflow Statistical Analysis

If a project is located on a gaged stream, it may be appropriate to use the recorded stream flow data to determine peak flow estimates for various return intervals. The period of record for the stream gage should extend at least 30 years if the 100-year return interval is to be estimated. The user is responsible for determining the reasonableness of the gage data considering the location of the project compared to the gage and changes in land use or other watershed characteristics that have occurred over time or are projected to occur. The USGS Guidelines for Determining Flood Flow Frequency Bulletin 17C (USGS, 2019) includes a variety of methods that may be applicable for this type of analysis.

<https://pubs.usgs.gov/tm/04/b05/tm4b5.pdf>

6.7 StreamStats

StreamStats is an online tool provided by the United States Geological Survey (USGS) to estimate peak flows for various return intervals at a given design point. While relatively easy to use, the estimates provided by StreamStats can have large margins of error that exceed those of more detailed hydrologic analyses. When using StreamStats results, the user should review the reported margin of error and consider applying a safety factor (i.e., increasing the design flow) to provide a level of conservativeness. The County Engineer will generally only approve StreamStats estimates for relatively small, low-risk projects on private property and must be approved by the County Engineer prior to submittal.

<https://streamstats.usgs.gov/ss/>

6.8 Offsite Flows (Upstream)

Hydrologic analysis is required to quantify upstream, offsite flows that drain through a proposed project area. Offsite flows shall be based on fully developed conditions as defined by existing drainage master plans or other planning documents. If such plans do not exist, then existing conditions may be used. Additionally, the County may require that a drainage easement be acquired for the areas where offsite flows are conveyed. The engineer shall consult with the County Engineer to determine the project-specific requirements of the hydrologic analysis and easement.

6.9 Post-Fire Runoff Considerations

The hydrologic response of watersheds impacted by wildfire can be significantly greater than natural conditions. Burned vegetation and soil result in a reduction of interception/infiltration losses and shorter overland flow paths that ultimately increase runoff volumes and peak flows. Experience in Colorado has shown that a 2-year rainfall event can produce post-fire runoff peaks and volumes exceeding the pre-fire 10/25-year peaks and volumes. These conditions are typically most significant in the first 5 years after a wildfire and can last for over 10 years depending on various factors.

The design engineer should make appropriate considerations for these changes when working on any project in/near recent wildfire-impacted watersheds. For example, various hydrologic modeling parameters may have to be modified from their typical values to appropriately account for the increased hydrologic response. Several publications are available online that provide guidance for post-fire hydrologic modeling, including the Natural Resource Conservation Service (NRCS) publication, *Hydrologic Analyses of Post-Wildfire Conditions, Hydrology Technical Note No. 4* (NRCS, 2016). The design engineer is encouraged to discuss appropriate modeling methods with the County Engineer prior to developing submittals.

6.10 Submittal Requirements

Drainage Reports shall include the following information (at a minimum) to document runoff calculations:

- Discussion of hydrologic method(s) used, including assumptions and references used for parameter selection,
- Plans showing delineation, area and runoff coefficients/imperviousness of subbasins,
- Spreadsheets showing all Rational Method calculations, including references for equations used for different spreadsheet columns and calculations, and
- Print outs of modeling input files and summary tables/figures of model outputs at critical design points.

6.11 References

Natural Resource Conservation Service (NRCS), 2016. Hydrologic Analysis of Post-Wildfire Conditions – Hydrology Technical Note No. 4. August 2016.

United States Geological Survey (USGS), 2019. Guidelines for Determining Flood Flow Frequency – Bulletin 17C, Version 1.1. May 2019.

CHAPTER 7.0 STREETS

7.1 Introduction

This chapter provides criteria for allowable drainage encroachment in streets and roadways in the County and procedures for determining encroachment.

The primary function of streets and roadways is to provide safe traffic movement, therefore stormwater drainage and conveyance in streets must be designed to prevent or minimize interference with that objective. Encroachment criteria are based on the classification of the street/roadway being evaluated and are different for the minor and major events. Minor event criteria are more stringent because those events occur more frequently and would otherwise impede traffic movement more frequently. Similarly, criteria are generally more stringent for higher traffic streets/roadways (e.g., arterials) compared to those with lower traffic (e.g., local roadways). To meet encroachment criteria, the engineer must generally design a storm drain system or open channel system (e.g., roadside swales) along with adequate placement of inlets to convey excess flows off the streets/roadways.

7.2 Street Classifications

Streets shall be classified as Local, Minor Collector, Major Collector, or Arterial depending upon their functionality and Urban or Rural depending on their location. The link below is the County's most recent (2018) functional classification map, however these classifications are updated periodically so it is recommended to check the County's website for the most up-to-date version.

https://www.larimer.gov/sites/default/files/uploads/2018/functional_classification_36x48.pdf

For more detailed information regarding street classifications within the County, please refer to the Larimer County Urban Area Street Standards and Larimer County Rural Area Road Standards.

7.3 Minor and Major Events

Table 7-1 presents the minor and major storm events to be used for encroachment analysis. The minor storms are different for rural and urban streets/roadways.

Table 7-1 Minor and major storm design events for rural and urban streets and roadways

Roadway Location	Minor Storm	Major Storm
Rural	10-year	100-year
Urban	2-year	100-year

7.4 Encroachment and Cross-Street Flow Criteria

Encroachment criteria for the minor storm event (Table 7-2) and major storm event (Table 7-3) are presented below.

Table 7-2 Encroachment criteria for minor storm event

Street Classification	Maximum Depth and Inundation Area
Local	No curb overtopping allowed. Where there is no curb, flows may not encroach beyond the edge of ROW. Flow may spread to crown.
Minor Collector	No curb overtopping allowed. Where there is no curb, flows may not encroach beyond the edge of ROW. One lane must be kept free of water.
Major Collector & Arterial	No curb overtopping allowed. Where there is no curb, flows may not encroach beyond the edge of ROW. One lane must be kept free of water in each direction.

Table 7-3 Encroachment criteria for major storm event

Street Classification	Maximum Depth and Inundation Area
Local	Maximum depth of water is 6" over the crown or 12" at the edge of pavement (whichever is more restrictive). Buildings shall have at least 18" of freeboard*.
Minor Collector	Maximum depth of water is 6" over the crown or 12" at the edge of pavement (whichever is more restrictive). Buildings shall have at least 18" of freeboard*.
Major Collector & Arterial	No inundation over the crown. Maximum depth of water at edge of pavement is 12". Buildings shall have at least 18" of freeboard*.
*Freeboard requirements are based on the water surface elevation in the street/roadway. Where freeboard requirements cannot be met, buildings shall be floodproofed according to the County floodplain regulations.	

Cross-street flow can occur under several conditions; 1) where runoff spreads across the crown of a roadway, 2) where runoff is conveyed across an intersection in a cross-span and 3) where a roadway is overtopped due to culvert or bridge capacity constraints. Cross-flow depths that are not within a cross-span must meet the requirements in Table 7-2 and Table 7-3 above. Allowable cross-street flow depths using cross-pans are provided in Table 7-4.

Table 7-4 Allowable cross-street flow depths using cross-pans

Street Classification	Minor Storm Flow	Major Storm Flow
Local & Minor Collector	6" depth in cross-pan	12" depth in cross-pan
Major Collector & Arterial	No cross flow allowed	No cross flow allowed

7.5 Design Procedures

Hydraulic calculations must be completed to determine the capacity of street cross sections and the resulting encroachment. These calculations are often performed in conjunction with inlet calculations and/or roadside swale calculations. The engineer shall perform these calculations according to the procedures outlined in the *Streets, Inlets and Storm Drains* chapter of the MHFD Manual. The MHFD-Inlet design spreadsheet incorporates many of these design procedures and is recommended to be used within the County.

7.6 Submittal Requirements

Drainage Reports shall include the following information (at a minimum) to document street capacity calculations:

- Drawing plans shall identify the classification of all roadways,
- Drawing plans shall include cross-sections showing maximum extents of encroachment, flow depths and water surface elevations, and
- All cross pans shall be labeled on drawing plans.

CHAPTER 8.0 INLETS

8.1 Introduction

This chapter provides the criteria and methodology for design and evaluation of storm drain inlets located in the County. The primary purpose of storm drain inlets is to intercept excess surface runoff and convey it into a storm drainage system, thereby reducing or eliminating surface flooding.

8.2 Inlet Types and Application

Most inlets fall within one of four types: grate, curb-opening, combination, and slotted. Table 8-1 provides a description of the most applicable setting for each type. Inlets are further classified as being on a “continuous grade” or in a “sump.” Roadway geometry often dictates the location of street inlets located along the curb and gutter. In general, inlets are placed at all low points (sumps), along continuous grade curb and gutter, median breaks, intersections, and crosswalks. The spacing of inlets along a continuous grade segment of roadway is governed by the allowable spread of flow and flow depth. See further details of allowable spread of flow in CHAPTER 7.0, Streets.

Inlets on **continuous grade** are placed in a section of curb and gutter on a continuous slope such that ponding does not occur when the inlet capacity is exceeded.

Inlets are also placed in **sump** conditions. Sump conditions exist wherever ponding occurs, such as at low points.

Table 8-1 Inlet type and application

Inlet Type	Applicable Setting	Advantages	Disadvantages
Grate	Sumps and continuous grades (should be made bicycle safe)	Perform well over wide range of grades	Can become clogged and lose some capacity with increasing grade
Curb-opening	Sumps and continuous grades (but not steep grades)	Do not clog easily	Lose capacity with increasing grade
Combination	Sumps and continuous grades (should be made bicycle safe)	High capacity and do not clog easily	More expensive than grate and curb-openings alone
Slotted	Locations where sheet flow must be intercepted	Intercept flow over wide section	Susceptible to clogging

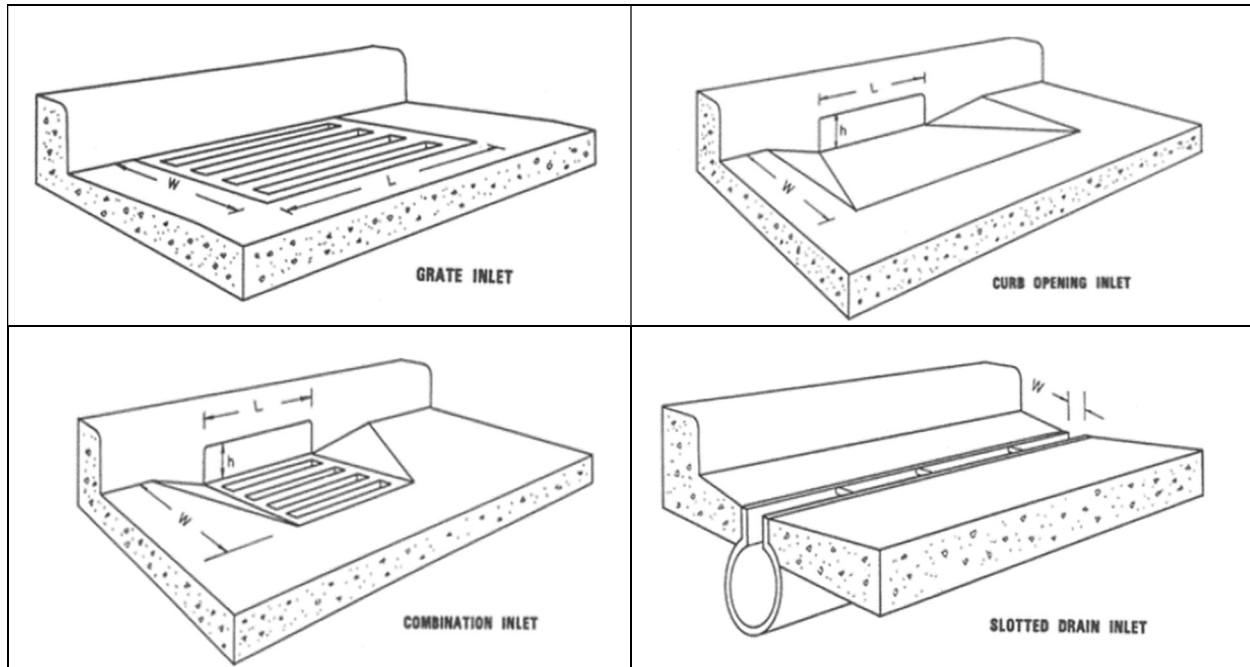

Figure 8-1: Perspective view of different inlet types

8.3 Design Procedures and Considerations

Inlet design includes both determining hydraulic capacity and appropriate inlet placement. The engineer shall follow the inlet design procedures and considerations outlined in the *Inlets* chapter of the MHFD Manual to determine appropriate inlet types, sizes, and locations. The County recommends the UD-Inlet software, downloadable from the MHFD website, be used for all inlet calculations.

8.4 Submittal Requirements

Drainage Reports shall include the following information (at a minimum) to document inlet design and application:

- Spreadsheet tables showing street capacity, runoff and inlet calculations. The use of MHFD-Inlet workbook is preferred, but not required. If the MHFD-Inlet workbook is not used, all equations used to calculations must be documented.
- Plans shall show the locations and type of inlets.
- For sump inlets, plans shall show the emergency overflow path and maximum ponding elevation for the major event, assuming the inlets become clogged.

CHAPTER 9.0 STORM DRAINS

9.1 Introduction

This chapter provides design criteria and procedures for all storm drains within the County public right-of-way or easements. Storm drains provide subsurface conveyance of runoff where surface drainage is not adequate or possible. Storm drains must be sized to carry the portion of runoff that cannot be conveyed on the surface, as dictated by the available capacity in streets and roadside swales during minor and major storm events.

Rural Areas

Storm drains are not preferred in rural areas due to higher construction and maintenance costs compared to open swales. Swales also provide additional benefits such as runoff reduction and pollutant removal. Projects that propose to include storm drains in rural areas should be discussed with the County Engineer prior to development of submittal documents.

Note: culverts are not considered storm drains in this context

9.2 Pipe Sizes and Materials

All storm drains within the County public right-of-way or easements shall be a minimum of 15 inches diameter (or the hydraulic equivalent if other than circular) and reinforced concrete pipe (RCP) of Class 3 or greater.

9.3 Manholes

Manholes are required at all pipe junctions (including laterals servicing inlets), as well as changes in pipe size, alignment, elevation, or slope. A minimum diameter of 4 feet is required for all manholes. Larger diameters may be required for larger pipes, when pipe alignment is not straight, or when multiple pipes share a manhole. Maximum spacing between manholes shall be no more than 400 feet, and the County may require manholes at spacing as close as 200 feet for pipes larger than 24" diameter depending on maintenance requirements and access. The design engineer should consult with the County Engineer on manhole spacing prior to developing submittal documents.

9.4 Storm Drain Outlets

Storm drain outlets shall have a headwall/wingwall or flared end section and appropriate erosion protection such as riprap aprons or low tailwater basins. Refer to the *Hydraulic Structures* chapter of the MHFD Manual for design criteria and considerations.

9.5 Storm Drain Cover

Cover depth and material shall be based on pipe manufacturer recommendations or, when traffic loadings are present, the American Association of State Highway and Transportation Officials (AASHTO) HS-20 loadings, whichever is more stringent. The minimum cover for any storm drain shall be 12 inches above the pipe crown.

9.6 Hydraulic Design

Storm drains shall be designed to convey the minor storm at 80% or less of full pipe capacity (without surcharging). A minimum velocity of 2 ft/sec for the minor storm is required to limit the accumulation of debris and sediment and the maximum velocity in the storm drain shall not exceed 20 ft/sec. The Manning's n values used for hydraulic calculations should be 0.013 or per manufacturer's recommendations. The energy grade line (EGL) shall be calculated as part of the hydraulic design and must account for pipe friction losses and pipe form losses. Total hydraulic losses must include friction, expansion, contraction, bend, and junction losses following the methods outlined in the *Streets, Inlets and Storm Drains* chapter of the MHFD Manual. The EGL shall be 6 inches or more below the manhole lid elevation or flowline elevation at the inlet for the major storm event.

Table 9-1. Allowable values for storm drain design parameters

Design Parameter	Allowable Value
Pipe size	Minimum 15 inches diameter (in public ROW or easement)
Pipe material	RCP Class 3 or greater (in public ROW or easement)
Manhole diameter	Minimum 4 feet
Manhole spacing	Maximum 400 feet
Storm drain cover	Minimum 12 inches above pipe crown
Flow depth	≤ 80% of pipe full-flow capacity for minor storm
Velocity	Minimum 2 ft/sec; maximum 20 ft/sec
Manning's n	0.013, or manufacturer's recommendation
EGL	≥ 6 inches below manhole lid elevation or flowline elevation at the inlet for major storm event

9.7 Design Procedures

The design of storm drain systems shall be performed in accordance with procedures outlined in the *Streets, Inlets and Storm Drains* chapter of the MHFD Manual. These procedures can be implemented using spreadsheets and/or other software (e.g., StormCAD, AutoDesk SSA, etc.) specifically designed for pipe hydraulic calculations.

The MHFD's UD-Sewer program is no longer supported by MHFD, however the County may still accept UD-Sewer results as long as the program is still operable with a current version of Microsoft Excel.

9.8 Submittal Requirements

Drainage Reports shall include the following information (at a minimum) to document storm drain design:

- Plans shall show location, size and ownership of all storm drains,
- Summary tables including pipe size, pipe capacity, flowrates, velocities, and HGL and EGL elevations,
- Profiles showing ground, HGL and EGL elevations,
- Schematics showing pipe network used in modeling software (if applicable), and
- Print outs of modeling software inputs and outputs.

CHAPTER 10.0 CULVERTS

10.1 Introduction

This chapter provides design criteria and procedures to be used for culverts within the County. Culverts are conduits that provide conveyance of surface water underneath roadways, driveways, and other types of embankments that cross surface water drainageways.

10.2 Design Criteria and Considerations

10.2.1 Additional Requirements, References and Guidelines

In addition to the criteria and considerations outlined in this chapter, culvert design may be dictated by:

- FEMA floodplains: Culverts constructed in a regulatory floodway must demonstrate no rise in water surface elevation, or a Conditional Letter of Map Revision (CLOMR) and Letter of Map Revision (LOMR) is required.
- Drainage Areas of Interest: Culverts constructed within a Drainage Area of Interest may be required to meet more stringent requirements than other areas in the County. The County's *Bridges and Culverts* guidance document provides additional information regarding regulations for construction of crossings in Larimer County Drainage Areas of Interest. This document may be accessed on the County's website, and all technical requirements shall be met as prescribed therein.
- Master Plans: Culverts must be designed in compliance with any existing Master Plans in effect for the watershed.

No Adverse Impact

These criteria are the minimum requirements for culvert design. *All crossings, public or private, must show no adverse impact on adjacent property for the 100-year storm event.* In some cases, more stringent criteria may be required to achieve this overarching requirement.

10.2.2 Culvert Classification, Design Event, Headwater Depths

Culverts must be sized to convey the discharge from a design event based on the type of crossing that the culvert is serving (

Table 10-1), referred to as the “Culvert Classification.” Figure 10-1 shows different culvert classifications. The headwater depth criteria dictate the maximum ratio of upstream headwater to the vertical dimension of the culvert. The overtopping depth represents the maximum allowable depth measured at the crown of the roadway for the 100-year event. If a crossing does not meet one of the classifications, consult with the County Engineer for appropriate design criteria.

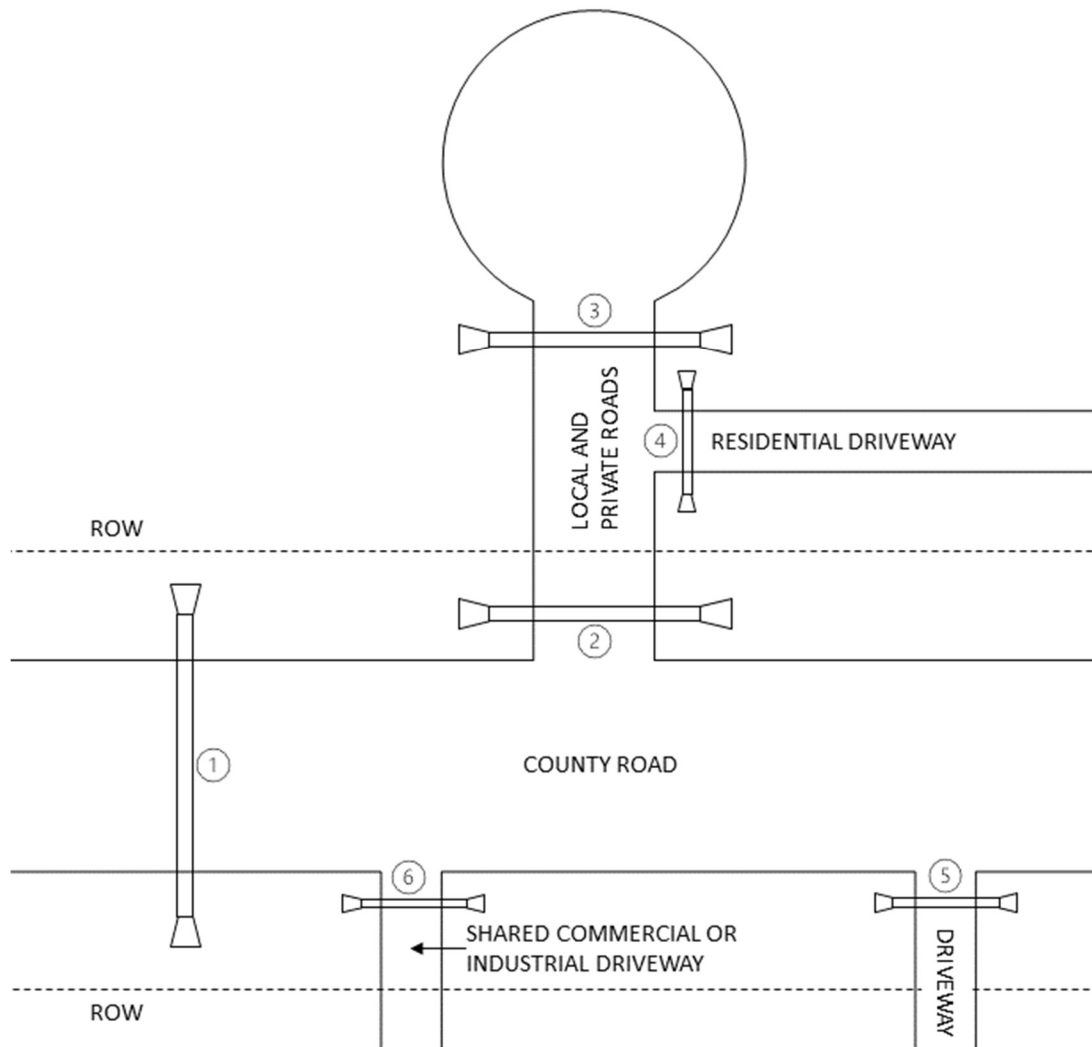

Figure 10-1. Culvert Classification Diagram

Table 10-1. Design Event, Maximum Headwater Depth and Overtopping Depth Criteria*

Culvert Classification	Road Classification/Description	Minimum Design Event	Headwater to Depth Ratio	Maximum Allowable Overtopping Depth for 100-Year Event
1	Public, Local	10-year	$H_w/D \leq 1.5$	6 inches
1	Public, Minor Collector	25-year	$H_w/D \leq 1.5$	6 inches
1	Public, Major Collector	100-year	$H_w/D \leq 1.5$	Not allowed
1	Public, Arterial	100-year	$H_w/D \leq 1.5$	Not allowed
2	Private, Local (in ROW)	10-year	$H_w/D \leq 1.5$	n/a**
3	Private, Local (not in ROW)	10-year	$H_w/D \leq 1.5$	n/a
4	Private, Driveway (Local, Private Rd Access)	10-year	$H_w/D \leq 1.5$	n/a
5	Private, Driveway (County Rd Access)	10-year	$H_w/D \leq 1.5$	n/a
6	Private, Driveway (Shared Access)	10-year	$H_w/D \leq 1.5$	n/a

*Design criteria are subject to all applicable floodplain regulations, adopted storm drainage master plans and demonstration of no adverse impacts to adjacent property.

**n/a = not applicable

10.2.3 Culvert Size and Material

Table 10-2 presents the minimum size and materials that are allowed based on the culvert classification.

If a non-circular culvert will be used, then the opening area shall be at least equivalent to the opening area of the corresponding minimum diameter circular culvert. Single-walled HDPE pipe and fiberglass end sections are prohibited. CMP should be 16-gauge or heavier and RCP should be Class 3 or above.

Table 10-2. Culvert Size and Material Requirements

Culvert Classification	Road Classification/Description	Minimum Size	Material
1	Public, Local	18"	RCP
1	Public, Minor Collector	18"	RCP
1	Public, Major Collector	18"	RCP
1	Public, Arterial	18"	RCP
2	Private, Local (in ROW)	18"	RCP
3	Private, Local (not in ROW)	18"	RCP, HDPE, CMP
4	Private, Driveway (Local, Private Rd Access)	15"	RCP, HDPE, CMP
5	Private, Driveway (County Rd Access)	15"	RCP, HDPE, CMP
6	Private, Driveway (Shared Access)	15"	RCP, HDPE, CMP

10.2.4 Inlet and Outlet Design

All culverts shall have a flared end section, headwall and/or wingwalls at both the upstream and downstream ends to protect against piping and erosion. Refer to the *Hydraulic Structures* chapter of the MHFD Manual for design guidance for these types of end treatments. Figure 10-2 provides an example end section design for a reinforced concrete circular pipe from the Colorado Department of Transportation. Flared-end sections are generally most appropriate for culverts 36 inches diameter or less.

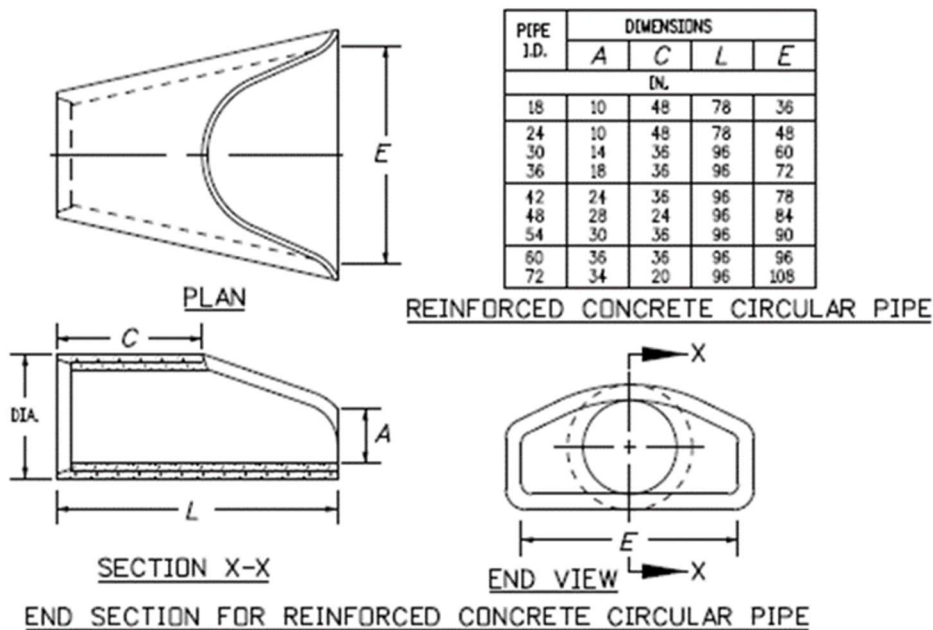

Figure 10-2. Example End Section for Reinforced Concrete Circular Pipe from CDOT Standard Plan No. M-603-10

10.2.5 Cover Depth

The cover depth above the crown of the culvert shall be a minimum of 12 inches for any culvert beneath a public roadway (e.g., Culvert Classification 1). The minimum cover depth for culverts under driveways directly accessing a County roadway shall also be 12 inches, unless otherwise allowed at the discretion of the County Engineer.

10.2.6 Velocity and Outlet Protection

Culverts shall be designed with a minimum velocity of 3 feet per second for the design flow to reduce sediment and debris accumulation. Outlet protection (typically rip-rap aprons) is required when velocities exceed 5 feet per second for the design discharge. For larger culverts a stilling basin may be required. The *Hydraulic Structures* chapter of the MHFD Manual contains design guidance for rip-rap aprons and other erosion protection measures located at culvert outlets.

10.2.7 Debris Control (Post-Fire Areas)

The engineer should consider if a new culvert may be impacted by recent wildfires in the contributing area upstream and take appropriate actions as necessary. These areas will produce higher than usual runoff rates and may also be subject to debris flows that can clog and damage culverts. The “Debris Control Structures Evaluation and Countermeasures” document from the Federal Highway Administration (FHWA, 2005) provides guidance for design of debris control structures.

10.3 Design Procedures

The engineer shall use the design procedures outlined in the *Culverts and Bridges* chapter of the MHFD Manual and/or methods presented in the “Hydraulic Design of Highway Culverts Manual” by the Federal Highway Administration (FHWA, 2012). These documents provide guidance on using capacity charts, nomographs and computer applications. The County encourages the use of either the MHFD-Culverts (formerly UD-Culverts) spreadsheet program or the FHWA HY-8 Culvert Analysis Program for computer applications. The use of other software programs for culvert design and analysis must be approved by the County Engineer.

10.4 Submittal Requirements

Submittal documents will vary based on the method and design procedures used. Capacity chart calculations may use the culvert design form provided in the *Culverts and Bridges* chapter of the MHFD Manual, or similar. All submittals shall include at least the following items:

- Headwater and tailwater depth/elevation,
- Embankment/roadway crown elevation,
- Design discharges,
- Culvert size, shape, and material,

- Inlet/outlet loss coefficients,
- Manning's n values,
- Minimum and maximum velocities,
- Printouts of inputs and outputs for all computer applications.

10.5 Permits

Culvert construction may require one or more permits from the County and other organizations. The applicant shall contact the County prior to providing any submittals to determine what permits will be required. Below is a list of some of the permits that may be required for culverts.

- Building Permit – Larimer County,
- Floodplain Development Permit – Larimer County,
- Right-of-Way Work Permit – Larimer County,
- Access Permit – Larimer County,
- Private Road Construction Permit – Larimer County,
- Development Construction Permit – Larimer County,
- Wild & Scenic Rivers – U.S. Forest Service,
- Section 404 Permit – Army Corps of Engineers,
- Native Endangered and Threatened Species – U.S. Fish and Wildlife Service,
- Water Quality Permits related to stormwater management and dewatering – Colorado Department of Public Health & Environment.

10.6 References

Bradley, J.B., Richards, D.L., and Bahner, C.D., 2005, "Debris Control Structures – Evaluation and Countermeasures", Hydraulic Engineering Circular No. 9, Third Edition, FHWA-IF-04-016, Federal Highway Administration, Washington, D.C.

Schall, J.D., Thompson, P.L., Zerges, S.M., Kilgore, R.T., and Morris, J.L., 2012, "Hydraulic Design of Highway Culverts", Hydraulic Design Series No. 5, Third Edition, FHWA-HIF-12-026, Federal Highway Administration, Washington, D.C.

CHAPTER 11.0 BRIDGES

11.1 Introduction

This chapter provides design criteria and procedures to be used for bridges within the County. Bridges provide passage above a surface water drainageway and are designed to minimize disturbance to flow.

11.2 Design Criteria and Considerations

Bridge design is dependent on several factors, including the roadway classification and the debris-potential of the stream. The design storm must pass underneath the low chord of the bridge with a minimum amount of freeboard to accommodate waves, debris, and ice. Most bridge construction results in some constriction of the stream channel, creating localized changes in flow, including the potential for backwater and increased velocity. Whether a stream is in a state of deposition or erosion influences the scour potential under the bridge. The design of any bridge is site specific, and the engineer is strongly encouraged to consult with the County early in the planning process.

These Standards do not provide guidance for structural design of bridges. For structural design, the engineer is directed to the American Association of the State Highway and Transportation Officials (AASHTO) *Standard Specifications for Highway Bridges*, the Colorado Department of Transportation (CDOT) *Bridge Design Manual*, *Larimer County Urban Area Street Standards* (LCUASS) and *Larimer County Rural Area Road Standards* (LCRARS).

11.2.1 Design Events

At a minimum, bridges shall be designed to convey the same minimum design event(s) required for culverts (Table 10-1), based on the road classification/description that the bridge is located on. However, different design events may be required under one or more of the following conditions:

1. Any bridge located in or crossing a FEMA floodplain shall be designed based on the 100-year design event. Bridges constructed in a regulatory floodway must demonstrate no rise in water surface elevation, or a Conditional Letter of Map Revision (CLOMR) and Letter of Map Revision (LOMR).
2. Bridges constructed within a Drainage Area of Interest may be required to meet more stringent requirements than other areas in the County. The County's Bridges and Culverts guidance document provides additional information regarding regulations for construction of crossings in Larimer County Drainage Areas of Interest. This document may be accessed on the County's website, and all technical requirements shall be met as prescribed therein.
3. Any bridge located in an adopted storm drainage basin master plan shall be designed based on design events/discharges defined in the plan.

11.2.2 Freeboard

Any bridge that must be designed to fully pass (without overtopping) the 100-year design event shall also provide freeboard between the low chord of the bridge and the energy grade line (EGL) according to the following:

1. If the 100-year design flow is less than 1,000 cfs, the freeboard shall be at least 1 foot
2. If the 100-year design flow is equal to or greater than 1,000 cfs, the freeboard shall be at least 2 feet.

11.2.3 Debris Control (Post-Fire Areas)

The engineer should consider if a new bridge may be impacted by recent wildfires in the contributing area upstream and take appropriate actions as necessary. These areas will produce higher than usual runoff rates and may also be subject to debris flows that can damage bridges. The *Debris Control Structures: Evaluation and Countermeasures* publication from the Federal Highway Administration (FHWA, 2005) provides guidance for design of debris control structures.

11.3 Design Procedures

11.3.1 Hydraulic Analysis

Guidance for performing hydraulic analysis can be found in the *Culverts and Bridges* chapter of the MHFD Manual. Additional references for bridge hydraulics include:

- Federal Highway Administration, *Hydraulic Design of Safe Bridges*, Hydraulic Design Series No. 7 (HDS-7), 2012.
- Federal Highway Administration, *River Engineering for Highway Encroachments – Highways in the River Environment*, Hydraulic Design Series No. 6 (FHWA HDS-6), December 2001.
- American Association of State Highway and Transportation Officials (AASHTO), *Highway Drainage Guidelines*, 2007. Chapter 7: Hydraulic Analysis for the Location and Design of Bridges.
- Arizona Department of Water Resources. *Design Manual for Engineering Analysis of Fluvial Systems*. March 1985.

11.3.2 Scour Analysis

Scour analysis shall be performed for all bridges to demonstrate the integrity of the structure will withstand flows in excess of the design event. All scour analysis shall be performed without the presence of riprap. Table 11-1 provides guidance for design flood frequencies to be used in scour analysis.

The following publications should be consulted for additional guidance for evaluating bridge scour and implementing countermeasures:

- Federal Highway Administration, *Evaluating Scour at Bridges*, Hydraulic Engineering Circular No. 18 (HEC-18), Fifth Edition, 2012.
- Federal Highway Administration, *Stream Stability at Highway Structures*, Hydraulic Engineering Circular No. 20 (HEC-20), Fourth Edition, 2012.
- Federal Highway Administration, *Bridge Scour and Stream Instability Countermeasures: Experience, Selection, and Design Guidance*, Hydraulic Engineering Circular No. 23 (HEC-23), Third Edition, 2009. Volumes 1 and 2.
- Colorado Department of Transportation, *Drainage Design Manual: Chapter 10 Bridges*, 2019.

Table 11-1. Hydraulic Design, Scour Design, and Scour Design Check Flood Frequencies (modified from HEC-18)

Hydraulic Design Flood Frequency, Q_D	Scour Design Flood Frequency, Q_S	Scour Design Check Flood Frequency, Q_C
Q_{10}	Q_{25}	Q_{50}
Q_{25}	Q_{50}	Q_{100}
Q_{50}	Q_{100}	Q_{500}
Q_{100}	Q_{500}	Q_{500}

11.4 Submittal Requirements

Submittal documents will vary based on the method and design procedures used. All submittals must include at least the following items:

- Design discharge,
- Backwater calculations,
- Elevation of low chord of bridge,
- Freeboard,
- Hydraulic analysis,
- Scour analysis (include contraction scour and local scour of piers and abutments), and
- Printouts of inputs and outputs for all computer applications.

11.5 Permits

Bridge construction may require one or more permits from the County and other organizations. The applicant shall contact the County prior to providing any submittals to determine what permits will be required. Below is a list of some of the permits that may be required for bridges.

- Building Permit – Larimer County,
- Floodplain Development Permit – Larimer County,
- Right-of-Way Work Permit – Larimer County,
- Access Permit – Larimer County,
- Private Road Construction Permit – Larimer County,

- Development Construction Permit – Larimer County,
- Land Disturbance Permit – Larimer County,
- Water Quality Permits related to stormwater management and dewatering – Colorado Department of Public Health and Environment
- Section 404 Permit – Army Corps of Engineers

11.6 References

Colorado Department of Transportation (CDOT), *Drainage Design Manual*, 2019.

Federal Highway Administration, *Debris Control Structures: Evaluation and Countermeasures*, Hydraulic Engineering Circular No. 9, (HEC-9), October 2005.

CHAPTER 12.0 OPEN CHANNELS

12.1 Introduction

This chapter includes criteria and procedures for the design of open channels in the County. In the Standards, open channels are classified as swales, roadside ditches, or naturalized channels. Swales can be used to convey onsite runoff to a design discharge point, typically a water quality/storage facility or a major drainageway. Swales can also be used to route offsite runoff around a site. In general, swales are sufficient for conveying discharges from contributing areas less than 130 acres. Roadside ditches are primarily intended to convey roadway runoff to a major drainageway. Naturalized channels are generally considered to be major drainageways designed to convey larger flows with a more defined baseflow/low-flow channel and floodplains.

12.2 Design Criteria and Considerations – Swales

12.2.1 Type

Swales can either be grass or riprap-lined, depending on conditions. Grass swales are preferred wherever conditions allow because they provide greater infiltration and filtration benefits and less maintenance requirements compared to riprap-lined swales.

12.2.2 Design Event and Freeboard

All swales shall be designed to convey the 100-year peak discharge. A minimum of 18" of freeboard must be provided above the 100-year water surface elevation to the top of the bank or adjacent property lines (whichever is more restrictive).

12.2.3 Cross-Section

A trapezoidal cross section is recommended for swales as it is the most efficient shape for conveyance and minimizes erosional forces. The bottom width should be at least 2 feet wide and side slopes should be 5:1 (H:V) or flatter for grass swales and 2.5:1 (H:V) or flatter for riprap-lined channels. If these criteria are followed, the swale capacity charts provided in Figure 12-1, Figure 12-2, Figure 12-3, and Figure 12-4 may be used for determining the type of swale for each application.

12.2.4 Hydraulic Design Requirements

12.2.4.1 Grass Swales

Grass swales shall be designed according to the criteria provided in Table 12-1 to maintain stability and reduce erosion potential. In addition, proper soil preparation and revegetation shall adhere to the criteria and guidelines provided in the *Revegetation* chapter of the Standards.

Table 12-1. Hydraulic design criteria for vegetated (grass) swales

Parameter	Erosive Soils	Erosion Resistant Soils
Maximum Velocity (2-year)	3.5 ft/sec	5.0 ft/sec
Maximum Velocity (100-year)	5.0 ft/sec	7.0 ft/sec
Maximum Froude Number (2-year)	0.5	0.7
Maximum Froude Number (100-year)	0.6	0.8

In some circumstances, grade control structures and/or riprap lined swales may be necessary. Refer to the *Hydraulic Structures* chapter of the Standards for design criteria on grade control structures.

12.2.4.2 Riprap-Lined Swales

Riprap-lined swales may use either soil riprap or void-filled riprap designs. Soil riprap is conducive to vegetation growth as the riprap voids are filled with topsoil. Void-filled riprap uses a well-graded mix of cobbles, gravels, sands, and soil to emulate a more natural streambed-like channel.

Design of riprap-lined swales requires determination of proper riprap size. Figure 12-1 through Figure 12-4 are swale stability charts showing the type of riprap to be used for various configurations of swale flowrate, longitudinal slope, bottom width, flow depth and side slope. Additional discussion on the development and application of the stability charts are available in the *Open Channels* chapter of the MHFD Manual.

If those conditions do not apply, the engineer may use alternative sizing methods. One method for riprap-lined swales with longitudinal slopes generally 2% or less is Equation 12-1 below (Hughes et al, 1983):

Equation 12-1

$$d_{50} \geq \left[\frac{VS^{0.17}}{4.5(G_s - 1)^{0.66}} \right]^2$$

Where:

V = mean channel velocity (ft/sec)

S = longitudinal channel slope (ft/ft)

d₅₀ = mean rock size (ft)

G_s = specific gravity of rock (minimum = 2.50, typically 2.5 to 2.7)

Several methods for sizing riprap on steep slope conditions are suggested and discussed in the *Open Channels* chapter (see Rocks and Boulders section) in the MHFD Manual. Construction notes and specifications for riprap projects are available in the Rock and Boulders section as well as the MHFD website Resource Library. <https://mhfd.org/resources/specifications/>

12.2.5 Common Area Lots, Outlots and Easements

The County requires all swales to be placed in common area lots, outlots or easements. See related policy statement in CHAPTER 3.0.

12.3 Roadside Ditches

Roadside ditches shall follow the design criteria set forth for swales, with the following exceptions:

1. The ditch capacity shall be dictated by the allowable encroachment criteria set forth in the *Streets* chapter of the Standards.
2. Alternative cross-sections (besides trapezoidal) may be used where necessary to meet available space or other constraints.
3. Drainage easements are not required if the 100-year water surface elevation is fully contained within the right-of-way.

12.4 Naturalized Channels

Major drainageways, defined as drainageways receiving runoff from contributing areas greater than 130 acres, shall be designed according to the naturalized channels criteria and guidelines set forth in the *Open Channels* chapter of the MHFD Manual and the County's floodplain regulations.

12.5 Hydraulic Analysis

All open channel designs shall be supported by a proper hydraulic analysis. In most cases, swale and roadside ditch design can be performed using Manning's Equation for uniform flow conditions. Multiple engineering design software packages such as FlowMaster, Autodesk SSA, HEC-15 and EPA SWMM support application of this method. HEC-RAS may be required for more detailed analysis, particularly for naturalized channels where bridges, culverts and other crossings can significantly affect hydraulics and where flood extents may need to be mapped.

12.5.1 Manning's Equation

Manning's Equation for uniform flow conditions is generally sufficient for swale and roadside design. The County Engineer will accept results from common engineering software packages that implement Manning's Equation.

Equation 12-2

$$Q = \frac{1.49}{n} AR^{2/3} S^{1/2}$$

Where:

Q = discharge (cfs)

n = Manning's roughness coefficient (see Roughness Coefficient sections below)

A = cross sectional area (ft²)

R = hydraulic radius (ft/ft)

S = friction slope (ft/ft) (approximated by channel invert slope for normal depth calculation)

The channel velocity (ft/s) can be computed as $V = Q/A$.

The Froude number can be computed as follows:

Equation 12-3

$$Fr = \frac{V}{\sqrt{gD_h}}$$

Where:

Fr = Froude number (dimensionless)

g = gravitational acceleration (32.2 ft/s²)

T = top width of flow area (ft)

D_h = hydraulic depth = A/T (ft)

12.5.2 Hydraulic Modeling

A more detailed analysis using software with one- or two-dimensional modeling capability will likely be required by the County for hydraulic analysis of naturalized channel projects. HEC-RAS remains a widely used and accessible program, and the engineer is encouraged to review the HEC-RAS modeling guidelines provided in the *Open Channels* chapter of the MHFD Manual as well as the HEC-RAS Hydraulic Reference Manual provided by the US Army Corps of Engineers. The County also has published guidelines for hydraulic analysis in its Floodplain Development Guide to support applications for floodplain permits. Other software, such as the U.S. Bureau of Reclamation's Sedimentation and River Hydraulics—Two-Dimension (SRH-2D) model, may be used with the County Engineer's approval.

12.5.3 Roughness Coefficients

Roughness coefficients are integral to open channel flow calculations and must be selected appropriately.

Table 12-2 provides typical roughness coefficients for various conditions. The engineer is responsible for field-verifying the conditions prior to use of the values in calculations.

Table 12-2: Typical roughness coefficients (based on Table 8-5 in MHFD Manual)

Location and Cover	For Velocity, Froude No., and Shear Stress Calculations	For Water Surface Elevation and Depth Calculations
Main Channel (bankfull channel)		
Sand or clay bed	0.03	0.04
Gravel or cobble bed	0.035	0.07
Vegetated Overbanks		
Turfgrass Sod	0.03	0.04
Native Grasses	0.032	0.05
Herbaceous wetlands (few or no willows)	0.06	0.12
Willow stands, woody shrubs	0.07	0.16

Roughness coefficients for void-filled or soil riprap-lined channels may be estimated using the equation below.

Equation 12-4

$$n = 0.0395d_{50}^{1/6}$$

12.6 Submittal Requirements

Drainage Reports shall include the following information (at a minimum) to document swale design:

- Plans shall show location, type and ownership of all swales,
- Plans shall include cross-sections showing bottom width, top width, side-slope, maximum water surface elevation and freeboard,
- Summary tables showing swale discharges, velocities and Froude numbers,
- Documentation of all equations, parameter values and calculations,
- Schematics showing pipe network used in modeling software (if applicable), and
- Print outs of modeling software inputs and outputs.

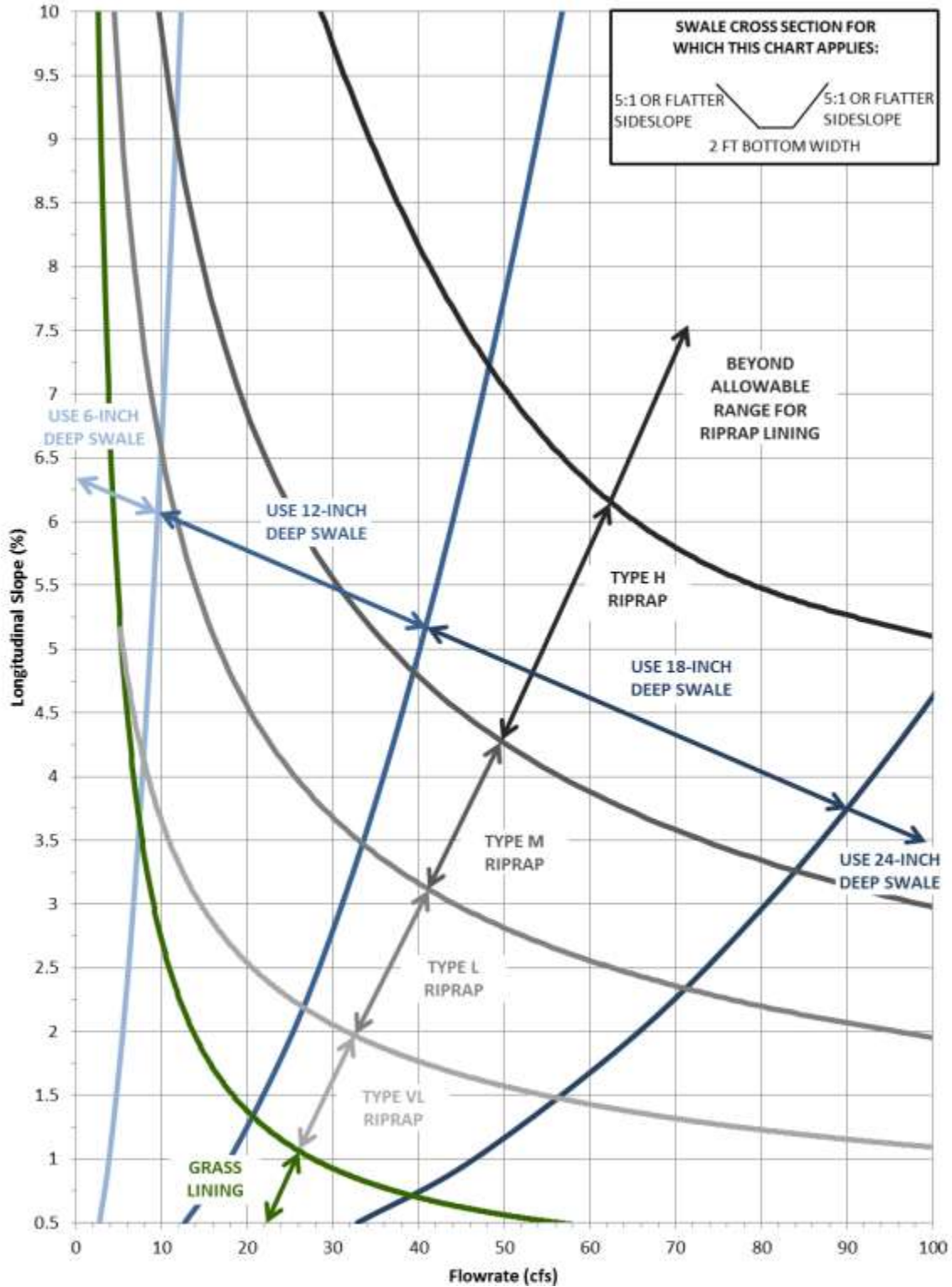

Figure 12-1. Swale stability chart: 2- to 4-foot bottom width and side slopes between 5:1 and 10:1 (Note: Riprap classifications refer to gradation for riprap used in soil riprap or void-filled riprap.) (Source: Muller Engineering Company from MHFD, USDCM Volume 1, Chapter 8)

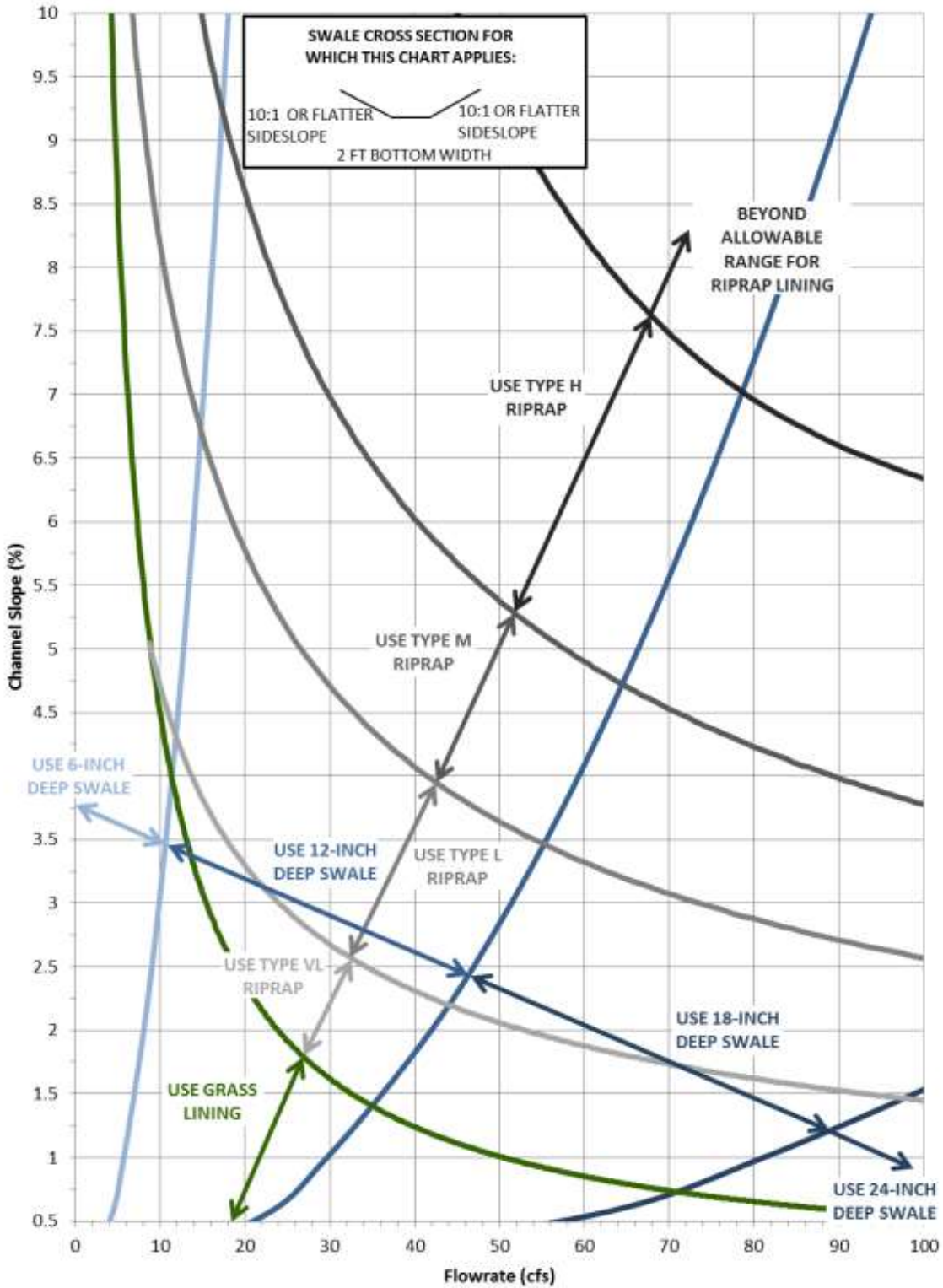

Figure 12-2. Swale stability chart: 2- to 4-foot bottom width and 10:1 (or flatter) side slopes (Note: Riprap classifications refer to gradation for riprap used in soil riprap or void-filled riprap.) (Source: Muller Engineering Company from MHFD, USDCM Volume 1, Chapter 8)

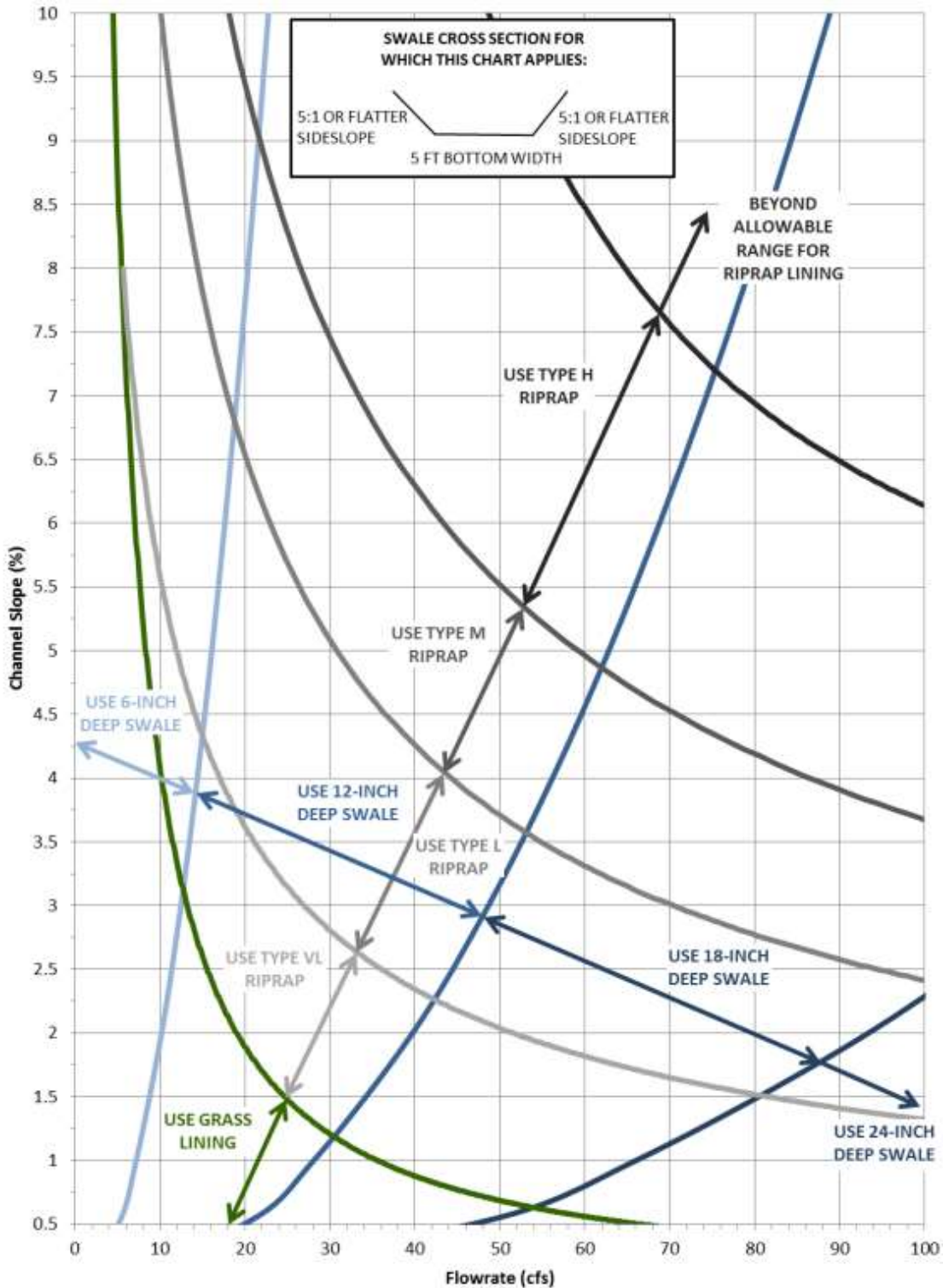

Figure 12-3. Swale stability chart: greater than 4-foot bottom width and side slopes between 5:1 and 10:1 (Note: Riprap classifications refer to gradation for riprap used in soil riprap or void-filled riprap.) (Source: Muller Engineering Company from MHFD, USDCM Volume 1, Chapter 8)

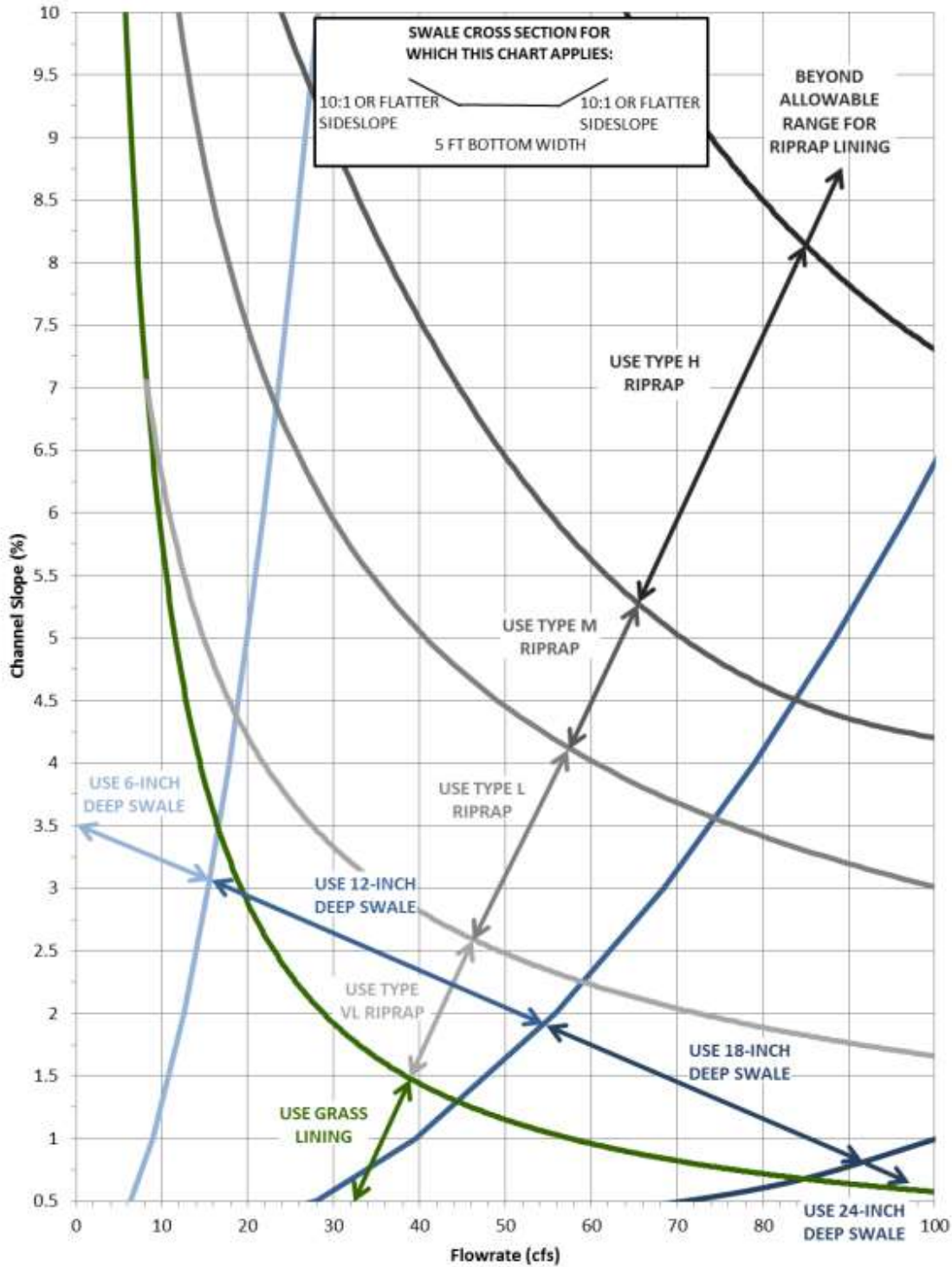

Figure 12-4. Swale stability chart: greater than 4-foot bottom width and 10:1 (or flatter) side slopes (Note: Riprap classifications refer to gradation for riprap used in soil riprap or void-filled riprap.) (Source: Muller Engineering Company from MHFD, USDCM Volume 1, Chapter 8)

CHAPTER 13.0 HYDRAULIC STRUCTURES

13.1 Introduction

Hydraulic structures include both grade control structures and pipe/culvert outfalls and rundowns. Grade control structures are used in open channels to reduce velocities and erosion potential. Outfalls and rundowns convey runoff from pipes and culverts into streams and open channels. The design criteria and considerations for hydraulic structures used in the County shall follow those provided in the *Hydraulic Structures* chapter of the MHFD Manual.

13.2 Supplemental Guidance

This section provides brief summaries of the circumstances that may require hydraulic structures and what hydraulic structures/design criteria may be required. This information is only intended to guide the engineer towards applicable design criteria and considerations and shall not be considered formal guidance from the County.

13.2.1 Grade Control Structures

Grade control structures are used in open channels to reduce velocities and erosion potential, for example, when grass swale velocities exceed those listed in Table 12-1. Grade control structures include the basic categories of grouted stepped boulder (GSB), sculpted concrete (SC) and vertical. The MHFD Manual includes a “simplified” design procedure and a “detailed” design procedure. In most cases, the design of grass swale and roadside ditch grade control structures can be performed using the “simplified” design approach with GSB or SC. Grade control structures in major drainageways will require a site-specific evaluation.

In all cases, GSB and SC are the preferred types of grade control structures. Vertical structures should only be considered where drop heights are lower than 2 feet and the use of GSB or SC is not practical.

13.2.2 Outfalls and Rundowns

All storm drain and culvert outlets are required to have proper end treatments and erosion control/energy dissipation structures. End treatments include flared-end sections or headwalls and wingwalls. Flared-end sections are generally most appropriate for pipes and culverts 36 inches diameter or less and may require a toe wall to prevent undercutting.

Table 13-1 includes several types of erosion control and energy dissipation structures and the conditions that typically warrant their application.

Table 13-1. Erosion control and energy dissipation structure types

Type	Typical application and considerations
Riprap Apron	<ul style="list-style-type: none"> • Conduit velocity < 15 ft/s • Discharge parallel to channel flow
Low Tailwater Basin	<ul style="list-style-type: none"> • Conduit velocity < 15 ft/s • Discharge perpendicular to channel flow • Low tailwater conditions (i.e., $T_w < 1/3$ conduit height)
Grouted Boulder "Rundown"	<ul style="list-style-type: none"> • Discharge into large streams/rivers, wetland channels • Outlet invert > 2 feet above tailwater elevation
Impact Basin (concrete)	<ul style="list-style-type: none"> • Conduit velocity > 15 ft/s • Low tailwater conditions

13.2.3 Rundowns

Rundowns convey channelized runoff from a pipe or paved area down a slope to an open channel or detention facility. Rundowns are strongly discouraged due to their high failure rate and maintenance requirements. Alternative options that should be evaluated include lowering the pipe invert or using level spreaders (from paved areas). If a rundown is required, grouted boulders are preferred over rip-rap or soil rip-rap.

13.3 Submittal Requirements

Submittal requirements for hydraulic structures will vary depending on the type and application and will generally include at the least the following:

- Discharge rates
- Flow velocities
- Hydraulic/erosion/energy dissipation calculations
- Explanation for selecting type of hydraulic structure

CHAPTER 14.0 DETENTION (STORAGE)

14.1 Introduction

This chapter provides design criteria and procedures to be used for detention facilities within the County. Detention facilities are designed to attenuate the increased runoff rates that occur as a result of development, namely those that increase the amount of impervious surface.

While this chapter focuses primarily on detention required to control downstream flooding and stream erosion, the engineer should understand that some Projects will also require water quality control to be provided. If both water quality and detention are required, it is often beneficial to consider facilities that can provide both. CHAPTER 15.0 addresses water quality controls and should be reviewed prior to developing detention plans and designs.

The engineer should also understand that incorporated communities within the County may have other detention requirements, some of which may be based on master planning efforts that extend into the community's growth management area (GMA). In general, a Project that is located within a GMA will be subject to that community's detention requirements. The County Engineer should be consulted to determine the appropriate detention requirements.

Finally, the engineer should refer to the *Storage* chapter of the MHFD Manual for any design criteria, considerations and guidance not specifically addressed in this chapter.

14.2 Threshold for Requiring Detention

The County will require detention for any Project that increases runoff to the extent that downstream properties and/or infrastructure could reasonably be perceived to experience adverse impacts (e.g., increased flooding, increased erosion, decreased level of service) as a direct result of the increased runoff from the development. This criterium is intended to protect public health, safety and the environment while also providing flexibility for requiring detention only where it is necessary to achieve those objectives.

The County will generally require detention for Projects with any of the following characteristics:

- Any Project with a disturbance of 1 acre or greater,
- Any Project that results in 5,000 square feet or more of new impervious surface, or
- Any Project that increases the imperviousness by 10% or greater compared to pre-development¹ conditions.
- Any Project where existing master plans require detention

¹ "Pre-development" in this case is considered to be the conditions of the site/property prior to the planned development. For example, if the existing conditions have 25% impervious surface, detention may only be required if the development increases the impervious surface to 35% or more.

The County may provide exemptions from detention requirements for Projects with the following characteristics:

- Additions to an existing structure on a residential lot,
- Development of a single parcel where total imperviousness is less than 25%,
- Single-lot residential development that is not part of a common plan of development, or
- Other situations that the County Engineer deems to be low risk for adverse downstream impacts.

If detention requirements are waived, the County may still require post-construction water quality and/or runoff reduction practices (see CHAPTER 15.0).

14.3 Detention Volume Requirements and Allowable Release Rates

The County requires detention be designed and operated according to the “Full Spectrum Detention” (FSD) approach outlined in the *Storage* chapter of the MHFD Manual. The FSD approach includes capture and control of two different runoff volumes, the excess urban runoff volume (EURV) and the 100-year runoff volume. The County allows the water quality capture volume (WQCV) to be “nested” within the EURV. The allowable release rate for the EURV is based on the allowable drain time for the type of detention facility being used. For example, extended detention basins must have an EURV drain time 52-72 hours when the WQCV is incorporated into the design. The 100-year runoff volume must be released at a rate no greater than 90% of the pre-development 100-year maximum runoff rate.

The EURV and 100-year runoff volumes shall be calculated based on the methods described in the *Storage* chapter of the MHFD Manual. Note: The “Simplified Equation” is only valid for contributing areas equal to or less than 10 acres.

The 100-year pre-development discharge may be calculated using Equation 12-5 of the *Storage* chapter of the MHFD Manual or more detailed hydrologic modeling. In either case, the undeveloped watershed imperviousness used must be no greater than 2%.

14.4 Types of Detention Facilities

See Table 14-1 for discussion on allowable and non-allowable types of detention facilities, as well as general application considerations.

Table 14-1: Types of Detention Facilities and Allowable Applications

Detention Facility Type	Application Considerations
Extended Detention Basin	Most common application of FSD. Best suited for larger sites with more than 2 acres of impervious area because orifice sizes become too small to avoid clogging.
Bioretention	Generally used for WQCV only, but can be modified to include FSD. Best suited for smaller sites with impervious areas less than 2 acres.
Sand Filter	Generally used for WQCV only, but can be modified to include FSD. Best suited for smaller sites with impervious areas less than 2 acres. Should only be considered over bioretention where sediment loads are expected to be high.
Parking Lot	Parking lot detention is <u>not allowed</u> in the County.
Underground	Underground detention is <u>not allowed</u> in the County due to inspection and maintenance difficulties.
Retention Ponds	Retention ponds are <u>not allowed</u> in the County due to complexities with verifying they can operate in accordance with <i>CRS §37-92-602(8)</i> . Retention basins also require acquisition of a water right and/or augmentation plan that often make them infeasible for most developments.

14.5 Detention and Water Rights

All detention facilities must be designed and operated in accordance with Colorado Revised Statute *CRS §37-92-602(8)*. This statute requires, among others, that 97% of captured runoff from rainfall events equal to or less than the 5-year event must be drained or infiltrated within 72 hours. It also requires 99% of captured runoff from rainfall events equal to or greater than the 5-year event must be drained or infiltrated within 120 hours.

New stormwater detention and infiltration facilities requiring notification (see Table 14-2) must be reported to all parties on the Substitute Water Supply Plan (SWSP) Notification List maintained by the State Engineer. Information that must be provided includes:

1. Location of the facility,
2. Approximate surface area at design volume, and
3. Data demonstrating the facility has been designed in compliance with the release rate requirements of the statute, as described above. The Stormwater Detention and Infiltration Design Data (SDI) Sheet, downloadable from MHFD as the *Compliance Design Data Workbook*, is organized in the preferred format for the State Engineer’s Office portal, and its use is recommended.

The Stormwater Detention and Infiltration Facility Notification portal, developed by MHFD, may be used to complete the reporting requirement for new facilities and will automatically direct notifications to the required recipients. The compliance portal is located here:

<https://maperture.digitaldataservices.com/gvh/?viewer=cswdif>

Table 14-2: Types of facilities requiring notification per CRS §37-92-602(8) (From MHFD Memorandum regarding CRS §37-92-602(8))

BMP	Water Quality Only	Flood Control Included
Grass Buffers	Not Required	Not Required
Grass Swales	Not Required	Not Required
Bioretention (with or without an underdrain)	Not Required	Required
Green Roof	Not Required	N/A
Extended Detention Basin	Required	Required
Sand Filter	Not Required	Required
Permeable Pavement Systems	Not Required	Required
Media Filter Drain	Not Required	Not Required
Underground Detention Vaults	Required	Required
Constructed Wetland Pond	N/A, Subject to Water Rights	
Constructed Wetland Channel	N/A, Subject to Water Rights	
Retention Pond	N/A, Subject to Water Rights	

14.6 Design Criteria and Considerations

The design of detention facilities shall follow the criteria, methods and guidance provided in the *Storage* chapter of the MHFD Manual. These address aspects of detention facility design such as grading, embankments, side slopes, freeboard, emergency spillways, outlet structures, trash racks and others.

- In addition, the lowest floor elevation for buildings adjacent to a storage facility must be higher than the embankment crest elevation of the storage facility.

14.7 Impacts to Downstream Property and Infrastructure

All designs shall also consider impacts to downstream property and infrastructure. The engineer shall demonstrate that downstream infrastructure has sufficient capacity to safely convey design discharges from the detention facility. If sufficient capacity or infrastructure does not exist, the developer may be responsible for downstream improvements.

14.8 Maintenance

All detention facilities shall be considered privately-owned, and maintenance will be the responsibility of the property owner. The property owner is encouraged to follow maintenance procedures and recommendations outlined in *Volume 3* of the MHFD Manual. The County has the right to inspect a facility at any time and require maintenance at the owner's expense.

The design engineer is encouraged to employ design techniques that reduce maintenance needs and expense. There is guidance on these design techniques in both the *Storage* chapter and Volume 3 of the MHFD Manual.

14.9 Submittal Requirements

Drainage Reports shall include the following information (at a minimum) to document detention facility design:

- Plans shall show location, type and ownership of detention facilities,
- Plans shall show water surface elevations and volumes of the WQCV, EURV and 100-year and 100-year freeboard elevation,
- Plans shall show the emergency overflow location, direction of flow and discharge.
- Summary tables of required WQCV, EURV and 100-year storage volumes along with supporting calculations,
- Summary tables of required and provided discharge rates and drawdown times along with supporting calculations, and
- Print outs of modeling software inputs and outputs.

The County recommends use of the MHFD-Detention workbook for FSD design and calculations.

14.10 References

Mile High Flood District. New Colorado Revised Statute §37-92-602(8) explanation memo and FAQ's: [https://mhfd.org/wp-content/uploads/uploads/resources/guidance%20documents/UDFCD Stormwater Legislation Memo 2016-03-09.pdf](https://mhfd.org/wp-content/uploads/uploads/resources/guidance%20documents/UDFCD_Stormwater_Legislation_Memo_2016-03-09.pdf)

Colorado Division of Water Resources. Administrative Statement Regarding the Management of Storm Water Detention Facilities and Post-Wildland Fire Facilities in Colorado: <https://dnrweblink.state.co.us/dwr/ElectronicFile.aspx?docid=3576581&dbid=0>

CHAPTER 15.0 POST-CONSTRUCTION STORMWATER CONTROLS

15.1 Introduction

Development projects can increase runoff and the discharge of undesirable pollutants that, if left untreated, may be detrimental to the health of receiving waters. This chapter addresses the use of post-construction stormwater control measures (SCMs) that are intended to reduce runoff and prevent or reduce discharge of pollutants to the County's waterways.

The Standards set forth in this chapter are based on the MHFD's Four Step Process for the protection of receiving waters from stormwater impacts, and the County's MS4 permit requirements for post-construction stormwater controls.

15.1.1 Four Step Process for Stormwater Quality Management

The Four Step Process is a long-standing approach recommended by the MHFD for stormwater quality management. The four steps are summarized below and additional information can be found in Volume 3 of the MHFD Manual.

Step 1: Employ Runoff Reduction Practices

This step aims to reduce the amount of runoff generated from a development by implementing low impact development (LID) practices and minimizing directly connected impervious area (MDCIA). Effective implementation of these practices requires careful planning at the beginning of the design process – looking for opportunities to route runoff through vegetated areas, preserve areas with high soil infiltration capacity, and minimizing impervious area overall. Quantifying runoff reduction via procedures in Volume 3 of the MHFD Manual can also result in smaller water quality and storage facilities downstream.

Principles of Low Impact Development (LID) and Minimizing Directly Connected Impervious Areas (MDCIA)

- Preserve natural hydrologic features and minimize disturbance
- Direct impervious surface runoff onto pervious areas
- Avoid concentrated flows where possible
- Utilize multiple controls throughout the site
- Use vegetated swales, buffers and distributed bioretention (rain gardens)
- Reduce volume, resulting in lower peak flows, reduced pollutant loadings, and hydrologic processes that more closely mimic the natural flow regime

Step 2: Implement SCMs That Provide a Water Quality Capture Volume with Slow Release

The runoff that is generated from a development should be captured in a SCM designed to contain and slowly release the water quality capture volume (WQCV). These SCMs provide pollutant removal benefits and, in some cases, additional runoff reduction. A wide variety of SCMs are available to achieve to these objectives; however, proper selection is important as not all SCMs are appropriate for all sites.

Water Quality Capture Volume (WQCV):

The volume of runoff used for optimal stormwater control measure design. Sizing for smaller volumes results in too many events exceeding the capacity of the facility, while designing for larger volumes results in drain times too short for effective pollutant removal.

Step 3: Stabilize Streams

Steps 1 and 2 may not always be sufficient to protect streams from erosion and additional measures may be necessary to keep a stream stabilized. In this context, the County considers “streams” to represent both major drainageways and minor drainageways that exist on or adjacent to a site. CHAPTER 12.0 of these standards addresses open channel design and stabilization techniques.

Step 4: Implement Site Specific and Other Source Control SCMs

This step aims to reduce or eliminate the potential for pollutants to enter the stormwater system on a site. This is particularly important for commercial and industrial sites that may handle or store chemicals, petroleum products or other materials that could cause severe impacts to receiving waters if discharged.

15.2 Runoff Reduction Practices (LID/MCDIA)

Runoff reduction practices shall be implemented to the extent practicable for all Projects. These requirements apply county-wide and regardless of Project size. If the Project is located within a GMA, more stringent requirements may apply.

15.2.1 Runoff Reduction Practices and Design Criteria

The following are the most common runoff reduction practices that can be used to achieve these requirements.

Grass Buffers: Grass buffers are densely-vegetated (typically turfgrass) areas designed to convey sheet flow from upstream impervious areas. The most important aspects of grass buffer design are to ensure that sheet flow is distributed evenly across the width of the buffer and that the buffer length (in the direction of flow) is long enough for effective treatment and infiltration.

Design criteria for grass buffers shall follow those included in Grass Buffer Fact Sheet in Volume 3 of the MHFD Manual.

Grass Swales: Grass swales are densely-vegetated channels designed to convey channelized flow from one location to another. They are most effective at runoff reduction and pollutant removal when designed with low flow depths and velocities – therefore design criteria for runoff reduction grass swales are different than open channel swales and roadside ditches. Design criteria for grass swales shall follow those included in Grass Swale Fact Sheet in Volume 3 of the MHFD Manual.

Permeable Pavement: Permeable pavement allows precipitation to flow through the pavement surface rather than producing runoff. It can also be used to store runoff below the pavement surface to achieve WQCV requirements or detention of larger flood control volumes. Design criteria for permeable pavement shall follow those included in Permeable Pavement Fact Sheet in Volume 3 of the MHFD Manual.

15.2.2 Submittal Requirements

At a minimum, the design engineer shall provide a qualitative discussion in the drainage report/letter on how runoff reduction practices will be implemented to the extent practicable and the design plans shall identify the runoff reduction practice locations and contributing impervious areas.

If the applicant intends to quantify runoff reduction for purposes of reducing downstream WQCV requirements, the design engineer shall also submit runoff reduction volume calculations using the most recent version of the UD-BMP Runoff Reduction Worksheet and detailed design plans/calculations for each practice to demonstrate they are designed according to the design criteria.

If runoff reduction practices cannot be feasibly implemented, a written justification must be provided to the County Engineer.

15.3 Water Quality SCMs

All Projects that disturb an area greater than or equal to 1 acre shall implement SCMs to meet one of the following base design standards, per the County's MS4 permit.

WQCV Standard: Control measures must be designed to provide treatment and/or infiltration of the WQCV for the entire Project site.

Pollutant Removal Standard: Requires treatment of the 80th percentile event to reduce the mean concentration of total suspended solids to 30 mg/L or less for the entire Project site.

Runoff Reduction Standard: Requires infiltration, evaporation, or evapotranspiration of 60% of the WQCV for the entire Project site.

Regional WQCV Facility Standard: If the Project site drains to a regional WQCV facility, at least 20% of the impervious area must be disconnected from the storm drainage system and drain through a receiving pervious area control measure comprising a footprint of at least 10% of the upstream disconnected impervious area.

Constrained Redevelopment Site Standard: If the Project is redevelopment with greater than 75% impervious area and the applicant demonstrates it is not practicable to meet any of the above standards, then the SCM(s) must meet one of the following:

- Meet the WQCV Standard for at least 50% of the impervious area
- Meet the Pollutant Removal Standard for at least 50% of the impervious area
- Infiltrate, evaporate or evapotranspire 30% of the WQCV calculated based on the overall site impervious area.

These base design standards are summarized from the County’s MS4 permit and shall not be interpreted differently from the permit requirements. These standards are also subject to change with future permit revisions.

Exemptions to the water quality SCM requirements may be provided if the Project meets any of the following characteristics:

- Single-family residential lots greater than or equal to 3 acres with a single dwelling and total imperviousness less than 10%, or
- Other “Excluded Sites” as defined in the County’s current MS4 permit.

If the Project is located within a GMA, more stringent requirements may apply.

15.3.1 SCM Selection and Application

There is a wide variety of SCMs that can be used to meet the WQCV requirements, however not all SCMs are appropriate for all Projects. The design engineer shall consider factors such as the contributing impervious area, soil type, depth to bedrock/groundwater and impaired waters when selecting the appropriate SCM(s) for a site. Additionally, some SCMs can be incorporated into full-spectrum detention facilities to provide both water quality and storage requirements in a single facility. Table 15-1 below summarizes the most common SCMs and general guidance for selection and application. Volume 3 of the MHFD Manual provides additional guidance that should be considered.

Table 15-1. Water Quality SCM Selection and Application

SCM	Selection and Applicability Considerations
Bioretention	Best-suited for capturing runoff from less than 5 acres of impervious area. Partial- or full-infiltration designs depend on soil type or infiltration rate testing results. Can be designed as a stand-alone WQCV SCM, or incorporated as the WQCV/EURV component of a full-spectrum detention facility.
Constructed Wetland Pond	Best-suited for capturing runoff from more than 5 acres and where consistent baseflows are present. Subject to water rights law that may require reporting and augmentation plans. Can be designed as a stand-alone WQCV SCM, or incorporated as the WQCV/EURV component of a full-spectrum detention facility.
Extended Detention Basin (EDB)	Best-suited for capturing runoff from more than 5 acres of impervious area and are <u>not allowed for contributing areas with less than 1 impervious area</u> . Can be designed as a stand-alone WQCV SCM, or incorporated as the WQCV/EURV component of a full-spectrum detention facility.
Grass Swale	Applicable as a runoff reduction practice only. They do not capture and treat the WQCV. They may be used to achieve MS4 permit requirements if it can be demonstrated that they meet volume reduction requirements.
Grass Buffer	Applicable as a runoff reduction practice only. They do not capture and treat the WQCV. They may be used to achieve MS4 permit requirements if it can be demonstrated that they meet volume reduction requirements.
Green/Blue Roof	Applicable as a runoff reduction practice only or WQCV practice, depending on design. They may be used to achieve MS4 permit requirements if it can be demonstrated that they meet the Runoff Reduction or WQCV standards.
Permeable Pavement	Best-suited for parking lots, driveways and alleys with relatively low traffic loadings. Can be designed as a stand-alone WQCV SCM, or with additional flood detention. Partial- or full-infiltration designs depend on soil type or infiltration rate testing results.
Sand Filter	Best-suited for capturing runoff from less than 5 acres of impervious area. Partial- or full-infiltration designs depend on soil type or infiltration rate testing results. Can be designed as a stand-alone WQCV SCM, or incorporated as the WQCV/EURV component of a full-spectrum detention facility. Bioretention is preferred over sand filters in most applications; however, sand filters may be more appropriate where maintenance is expected to be more frequent due to higher solids loadings from the contributing area. Sand filters avoid the need for irrigation to establish or maintain vegetation.

Retention Pond	Best-suited for capturing runoff from more than 5 acres. Subject to water rights law that may require reporting and augmentation plans. Can be designed as a stand-alone WQCV SCM, or incorporated as the WQCV/EURV component of a full-spectrum detention facility. WQCV must be provided above the permanent pool and reliance on pumps to discharge captured runoff will not be allowed. Cannot be used with flood control in Larimer County.
Underground (proprietary) SCMs	Underground SCMs for water quality will not be allowed unless aboveground SCM options are infeasible. The applicant must demonstrate that the proposed SCM meets one of the MS4 permit base design standards.

SCM Selection for Impaired Waters
 Waterbodies with a pollutant concentration exceeding the water quality standard established for a designated use are listed as “impaired waters” under Section 303(d) of the Clean Water Act. A total maximum daily pollutant load, or TMDL, is established for impaired waters and places limits on the pollutant load that may be discharged to a receiving water body. For areas within the County draining to impaired waters, SCM selection must be predicated on the effectiveness of a control measure at treatment of the specific pollutant named in the TMDL. The International BMP Database is one resource that can be used to determine the effectiveness of different SCMs at treating specific pollutants. <https://bmpdatabase.org/>

15.3.2 Water Quality SCM Design Criteria

The WQCV shall be calculated according to following equation from Volume 3 of the MHFD Manual:

$$WQCV = a(0.91I^3 - 1.19I^2 + 0.78I) \qquad \text{Equation 15-1}$$

Where:

WQCV = Water Quality Capture Volume (watershed-inches)

a = Coefficient corresponding to SCM type and based on WQCV design drain time (See Table 15-2 below, taken from the MHFD Manual, Volume 3, *Calculating the WQCV and Volume Reduction* Chapter)

I = Contributing area imperviousness (percent expressed as a decimal) - Note: At a planning level, the imperviousness can be estimated based on the zoned density. When finalizing design, calculate imperviousness based on the site plan.

Table 15-2. Drain Time Coefficients for WQCV Calculations (Taken from MHFD Manual Volume 3)

Drain Time (hours)	Coefficient, a
12	0.8
24	0.9
40	1.0

SCMs shall be designed according to the criteria presented in the most recent version of Volume 3 of the MHFD Manual. Those criteria are presented in a series of Fact Sheets and are updated on a regular basis. Any exceptions to those criteria, or the use of SCMs not identified in Table 15-1, will require prior approval from the County Engineer.

15.3.3 Maintenance

The County requires all water quality SCMs be designed with consideration of maintenance access and requirements. In addition, an Operation and Maintenance Plan must be completed for all water quality SCMs and provided to the owner and the County. The owner will be responsible for maintaining the SCM such that it continues to function as designed. Per the Development Agreement, the County reserves the right to perform maintenance activities if the owner refuses or is incapable doing so and the County may seek reimbursement for all costs from the Owner.

15.3.4 Submittal Requirements

Drainage reports and plans shall include the following information (at a minimum) for all proposed water quality SCMs:

- Description and discussion of SCM type(s) and contributing area characteristics (e.g., total area, impervious area, etc.),
- Soil type and/or infiltration test results for infiltration-based SCMs (e.g., bioretention, sand filters, permeable pavement),
- WQCV calculations, and
- Operation and Maintenance Plan.

The County recommends use of the MHFD's UD-BMP workbooks to document many of the requirements above. Additional information may be required by the County Engineer on a case-by-case basis.

CHAPTER 16.0 CONSTRUCTION STORMWATER MANAGEMENT

16.1 Introduction

Larimer County maintains a construction stormwater management program to reduce or prevent the discharge of pollutants from construction activities to the storm drainage system and receiving waters. Stormwater quality is particularly vulnerable during construction activities due to exposed and disturbed soils, and the presence of various construction equipment and materials.

The County's construction stormwater management program is implemented to comply with the requirements of the County's MS4 Permit. The program is also designed to conform with requirements of the statewide General Permit for Stormwater Discharges Associated with Construction Activity, although the County is not directly responsible for enforcing the requirements of the latter. As such, the County's construction stormwater management program is based primarily on the following items:

- Development Construction Permit and Land Disturbance Permit – permits required by the County for various construction-related activities.
- Erosion and Sediment Control Plan (ESCP) – required by the County to document construction stormwater management plans.
- Construction Stormwater Management Guidance Document – a guidance document developed by the County to provide additional guidance on this topic, which may be updated more frequently than these Standards.
- The Construction BMPs chapter of the MHFD Manual for design and implementation of construction stormwater control measures (incorporated by reference).

Additional discussion of those items is presented in the following sections of this chapter.

16.2 Development Construction Permit

A Development Construction Permit (DCP) is one mechanism that the County uses to permit construction activities. All applications for DCPs are reviewed by County staff to determine if a drainage report or drainage letter is required as part of the submittals package. If a drainage report or drainage letter is required, County staff will also require an ESCP (see Section 16.4) and possibly a Land Disturbance Permit (see Section 16.3).

16.3 Land Disturbance Permit

A Land Disturbance Permit (LDP) was implemented in the County in 2023 (corresponding to the development and approval of these Standards). An LDP will be required for any project that disturbs at least 1 acre, or is part of a common plan of development, and is located within the

County’s MS4 permit boundary area. All LDPs will require submittal of an ESCP. The threshold for requiring an LDP will also require the applicant to obtain a statewide General Permit for Stormwater Discharges Associated with Construction Activity from CDPHE and prepare a Stormwater Management Plan (SWMP) in accordance with the requirements of that permit.

Larimer County MS4 Permit Boundary

- <https://maps1.larimer.org/gvh/?Viewer=LIL>
- Under “Layer List” turn on “Flood Information” Layer
- Under “Stormwater Layer” turn on “MS4 Permit Area”

16.4 Erosion and Sediment Control Plan

An Erosion and Sediment Control Plan (ESCP) shall be submitted and approved by the County prior to the start of any construction activities that require a Drainage Letter, Drainage Report, DCP, or LDP. In addition, the County may require an ESCP for projects that are in close proximity to wetlands and receiving waters, and/or are identified by County staff as having potential for significant erosion.

The primary elements of an ESCP are outlined below. The submittal requirements and level of detail required for each of the elements will vary by project and be based on the County Engineer’s discretion. Appendix C contains the ESCP checklist, which must be completed and submitted with the ESCP. The applicant shall refer to the Construction Stormwater Management Guidance Document and associated appendices for additional guidance and requirements on these elements.

16.4.1 General Information and Site Description

The ESCP must describe the characteristics of the site and the construction activities that are proposed and how those activities will affect land disturbance and stormwater drainage. Identify areas that will be disturbed and where stormwater runoff will discharge to during various stages of construction.

16.4.2 Construction Stormwater Control Measures

The ESCP must describe and display on maps all potential sources of pollutants associated with the construction activities and appropriate stormwater control measures (SCM) that will be used to reduce or eliminate the potential for those pollutants to discharge to receiving waters and storm drainage system. The applicant is encouraged to follow the Construction BMPs chapter of the MHFD Manual in the design and implementation of construction SCMs.

Components of Effective Construction Stormwater Management

- Erosion control practices are focused on preventing erosion and mobilization of soils/sediment from occurring in the first place. Typical erosion control practices include mulching, check dams and surface roughening.
- Sediment control practices are focused on preventing soils/sediments from reaching waterways once they have been mobilized by runoff. Typical soil control practices include sediment control logs, silt fences and inlet protection.
- Materials management practices are implemented to provide protection against various construction-related materials reaching waterways. Examples include fuel spills/leaks, concrete washout areas and portable toilets.
- Site management includes a variety of other activities that can be both structural and non-structural. Common types of site management practices include construction phasing, street sweeping and vehicle tracking controls. Practices that are typically more project-specific include dewatering operations and temporary stream crossings.

16.4.3 Inspections and Maintenance

The County requires routine site inspections be completed by the permittee to ensure that control measures function as designed and maintenance needs are promptly addressed.

16.4.4 Final Stabilization and Long-term Stormwater Management

At the completion of construction, all sites are required to reach final stabilization. A site will not be considered to have achieved final stabilization until the vegetation density of all disturbed areas reaches at least 70% of pre-construction density. A description of all practices used to achieve final stabilization and a revegetation plan are required as part of the ESCP.

16.4.5 Plan Map/Drawings

A spatial representation of the site must be included that depicts the area(s) of disturbance and the location of all potential sources of pollutants. The direction of stormwater flow through the site should be indicated, along with all SCMs used and any waters of the state. Additional details regarding items to be depicted on the drawings, standard construction symbols that should be used, and standard notes that must be included are described in the Guidance Document and associated appendices.

16.4.6 Erosion Control Escrow

The County requires an erosion control escrow be provided before construction will be approved. The developer is encouraged to contact the County early in the planning process for escrow amounts and calculation methods.

16.5 Enforcement

The ESCP shall be enforced following procedures outlined in the LCLUC.

16.6 REFERENCES

City of Fort Collins, 2018. Fort Collins Stormwater Criteria Manual.

Larimer County, 2021. Larimer County Land Disturbance Permit Checklist.

Larimer County, 2021. Larimer County Urban Area Street Standards.

Mile High Flood District, 2010. Urban Storm Drainage Criteria Manual, Volume 3: Stormwater Best Management Practices.

CHAPTER 17.0 REVEGETATION

17.1 Introduction

This chapter provides guidance for revegetation following land disturbance activities in the County. Construction activities typically result in soil disturbance and loss of stabilizing vegetation, often leading to erosion and creating an opportunistic environment for the establishment of invasive and nuisance weedy species. Restoring a healthy vegetation community protects topsoil, reducing erosion in upland areas and stabilizing channel banks. Healthy native plant communities suppress weeds, sustain ecosystems, sequester carbon and provide value to the local community. Proper revegetation is necessary to satisfy the requirements of most construction-related permits.

The *Revegetation* chapter of the MHFD Manual provides extensive guidance for revegetation of upland, riparian and wetland areas. These Standards provide a high-level overview of the various processes involved with revegetation and discussion of County-specific requirements that are not included in the MHFD Manual.

17.2 Site Preparation

Initial site preparation is essential for the successful re-establishment of vegetation and may vary depending on location and land use. For example, site preparation in an area devastated by wildfire will differ from that resulting from residential development. Evaluate the site and determine the type of plant community to be established based on elevation and hydrology. Prior to beginning construction, plan to stockpile as much topsoil as possible to be replaced following completion of construction activities. Soil testing is highly recommended to determine any necessary soil amendments.

Table 17-1 shows critical activities related to site preparation. Refer to the corresponding section of the *Revegetation* chapter of the MHFD Manual for discussion and guidance on these activities. In addition, the following County-specific requirements apply:

Weed Control - An integrated weed management plan (IWM), both during construction and following revegetation, shall be developed and implemented. Please refer to the Larimer County Weed District website (<https://www.larimer.gov/naturalresources/weeds>) for additional resources on preventing and managing weed infestations.

Table 17-1: Site preparation activities for revegetating upland, riparian and wetland habitats, with chapter references from the Revegetation chapter of the MHFD Manual

Revegetation Guidance Topic	
Activity	Section of <i>Revegetation</i> Chapter of MHFD Manual
Initial Hydrologic Evaluation	3.1
Initial Weed Evaluation and Control	3.2
Topsoil Preservation (including Existing Wetland Soil)	3.3
Soil Testing	3.4
Soil Amendment	3.5
Seed Bed Preparation	3.6
Tree Protection	3.7

17.3 Plant Material Selection

Plant selection will vary based on habitat type, schedule, budget and overall goals of a project. A vegetation site plan should be provided by a specialist trained in plant selection and revegetation.

Table 17-2 shows plant materials appropriate for different habitat types. Refer to the corresponding section of the *Revegetation* chapter of the MHFD Manual for additional discussion and guidance on these activities. In addition, the following County-specific requirements apply:

Seed Mix – The County has developed a preferred seed mix (see Appendix J) for revegetation. Alternative seed mixes may be used with prior approval from the County. Please refer to Section 17.8 of this chapter for seed mixes applicable to post-fire burn areas.

Table 17-2: Plant material for revegetating upland, riparian and wetland habitat types, with chapter references from the Revegetation chapter of the MHFD Manual

Plant Material	Section of <i>Revegetation</i> Chapter of MHFD Manual	Applicability to Habitat Type		
		Upland	Riparian	Wetland
Seed (permanent and temporary)	4.2	√	√	√ (limited)
Plugs	4.4.1	√	√	√
Containers	4.4.2	√	√	√
Bare Root	4.4.3	√	√	√
Balled and Burlapped (B&B)	4.4.4	√	√	√
Cuttings	4.4.5		√	√
Wetland Sod, Rhizomes, Tubers	4.5			√

Additional Plant Selection Resources

The Colorado Native Plant Society has produced a series of publications titled *Native Plant Garden Guides* as a resource for selecting low-water native plant species appropriate for planting in the various regions of Colorado. These resources are available on the Colorado State University (CSU) Extension office website.

17.4 Plant Installation

Installation methods will vary depending on the plant selection and habitat type for the project. Table 17-3 shows plant installation methods appropriate for different habitat types. Please refer to the corresponding section of the *Revegetation* chapter of the MHFD Manual for additional discussion and guidance on these activities.

Table 17-3: Installation methods for revegetating upland, riparian and wetland habitat types, with chapter references from the Revegetation chapter of the MHFD Manual

Installation Method	Section of <i>Revegetation</i> Chapter of MHFD Manual	Applicability to Habitat Type		
		Upland	Riparian	Wetland
Seeding (multiple methods)	5.1 & 5.2	√	√	√ (limited)
Herbaceous Plug, Containerized, B&B, and Bare Root Stock Installation	5.3	√	√	√
Cutting Installation	5.4		√	√
Transplanting Wetland Plants (Wetland Sod, Rhizomes, Tubers)	5.5			√

17.5 Mulching

Mulching serves to provide a protective layer for newly planted vegetation in upland and riparian areas. Proper mulching can provide benefits such as moisture retention, erosion protection and weed control that increase the chances for successful revegetation.

Please refer to the *Revegetation* chapter of the MHFD Manual for additional discussion and guidance on the mulching topics below:

- Individual Planted Trees and Shrubs,

- Seeded Areas, and
- Types of Mulch (straw, rolled erosion control products, hydromulch, compost).

In addition, the following County-specific requirements apply:

Use of Straw Mulch – The use of straw mulch will require prior approval by the County so that it is not used in sensitive areas. Approved use of straw must be crimped and applied with a tackifier to assure it remains in place.

17.6 Maintenance

Any successful revegetation plan must address long-term maintenance. Revegetated areas often need to be replanted in subsequent years and are vulnerable to opportunistic weed infestation before desirable plant species become well-established. Temporary or permanent irrigation may be required. Plans should include provisions for long-term monitoring and adaptive management of revegetated areas to ensure successful outcomes.

Maintenance topics in the *Revegetation* chapter of the MHFD Manual include the following:

- Irrigation,
- Replacing dead trees/shrubs and spot reseeding bare areas,
- Vegetation protection from animals,
- Weed management,
- Managing erosion in riparian areas, and
- Maintenance of wetland areas

17.7 Post-construction Monitoring

Post-construction monitoring may be required to ensure vegetation is properly re-established prior to closure of permits. During post-construction monitoring, it is important to replace dead vegetation as soon as the planting window is appropriate so that the warranty period is not unnecessarily extended.

A Development Construction Permit from the County will generally have a 2-year warranty period after construction activities are substantially complete. The warranty period for a Land Disturbance Permit and/or Erosion Control Plan will vary by project. Specific requirements for those permits are subject to change and shall follow the most recent permit guidance.

Refer to the MHFD Manual *Revegetation* chapter for additional discussion and guidance on monitoring during warranty periods and long-term.

17.8 Post-Fire Revegetation

The Larimer County Department of Natural Resources has produced a document, *Seed Mixes, BMPs and Guidelines for Seeding and Mulching in the Cameron Peak Burn Area*, providing guidance on seed selection and best management practices for revegetating post-fire areas. Included in the document are seed mixes and directions for reseeding at different tiers of elevation, beginning with 6,000 ft. The document may be downloaded here: https://www.larimer.org/sites/default/files/uploads/2021/cpr_seedmix_bmps_2021.pdf.

17.9 Submittal Requirements

Revegetation plans must be included in construction stormwater management plans and/or erosion and sediment control plans and should include the following items:

- Percent vegetative cover (pre-construction)
- Soil types
- Description of seedbed preparation strategy (e.g., decompaction, soil testing, soil amendments)
- Seed mixes and seed tags that identify species name, common name, seed application rate (lbs of PLS/acre) and method of seeding (drill, drill depth, broadcast, hydroseed, etc.)
- Description mulching strategy (e.g., product, application method) with justification that the strategy is appropriate for site slopes and estimated length of vegetation re-establishment.
- Weed Management Plan per requirements of the County Natural Resources Department

17.10 Permits

Revegetation plans may be required and reviewed as part of one or more of the following permits:

- Development Construction Permit – Larimer County,
- Land Disturbance Permit – Larimer County,
- Construction Stormwater Discharge Permit – Colorado Department of Public Health and Environment, and
- CWA 404 Permit – US Army Corps of Engineers.

17.11 References and Resources

The following provide revegetation guidance:

Colorado State University (CSU) Extension Office: <https://extension.colostate.edu/>

Natural Resources Conservation Service (NRCS):
<https://www.nrcs.usda.gov/wps/portal/nrcs/site/national/home/>

Larimer County Weed District: <https://www.larimer.gov/naturalresources/weeds>

Larimer County Department of Natural Resources. Seed Mixes, BMPs and Guidelines for Seeding and Mulching in the Cameron Peak Burn Area. April 2021.

MHFD, USDCM Volume 2, *Revegetation* chapter

Colorado Natural Areas Program. *Native Plant Revegetation Guide for Colorado*. October 1998.

Colorado Native Plant Society. Low-Water Native Plants for Colorado Garden